

# STARTING SYSTEM

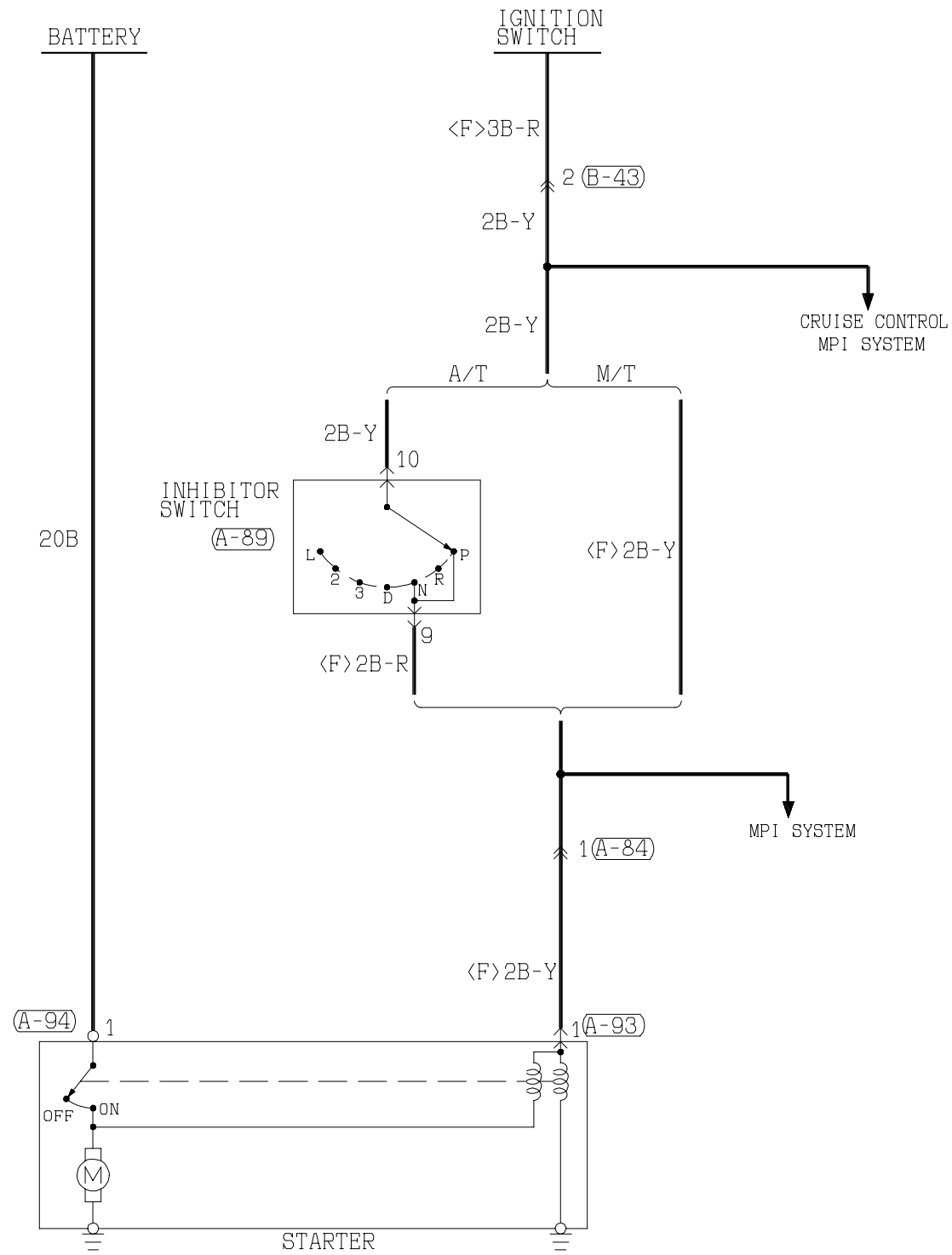

MPI SYSTEM <Automatic Transmission Vehicles>

Main Index

54 Index

54C 08/01

A

B

C

D

E

F

G

H

J

K

Main Index

54 Index

54C 08/01

A

B

C

D

E

F

G

H

J

K

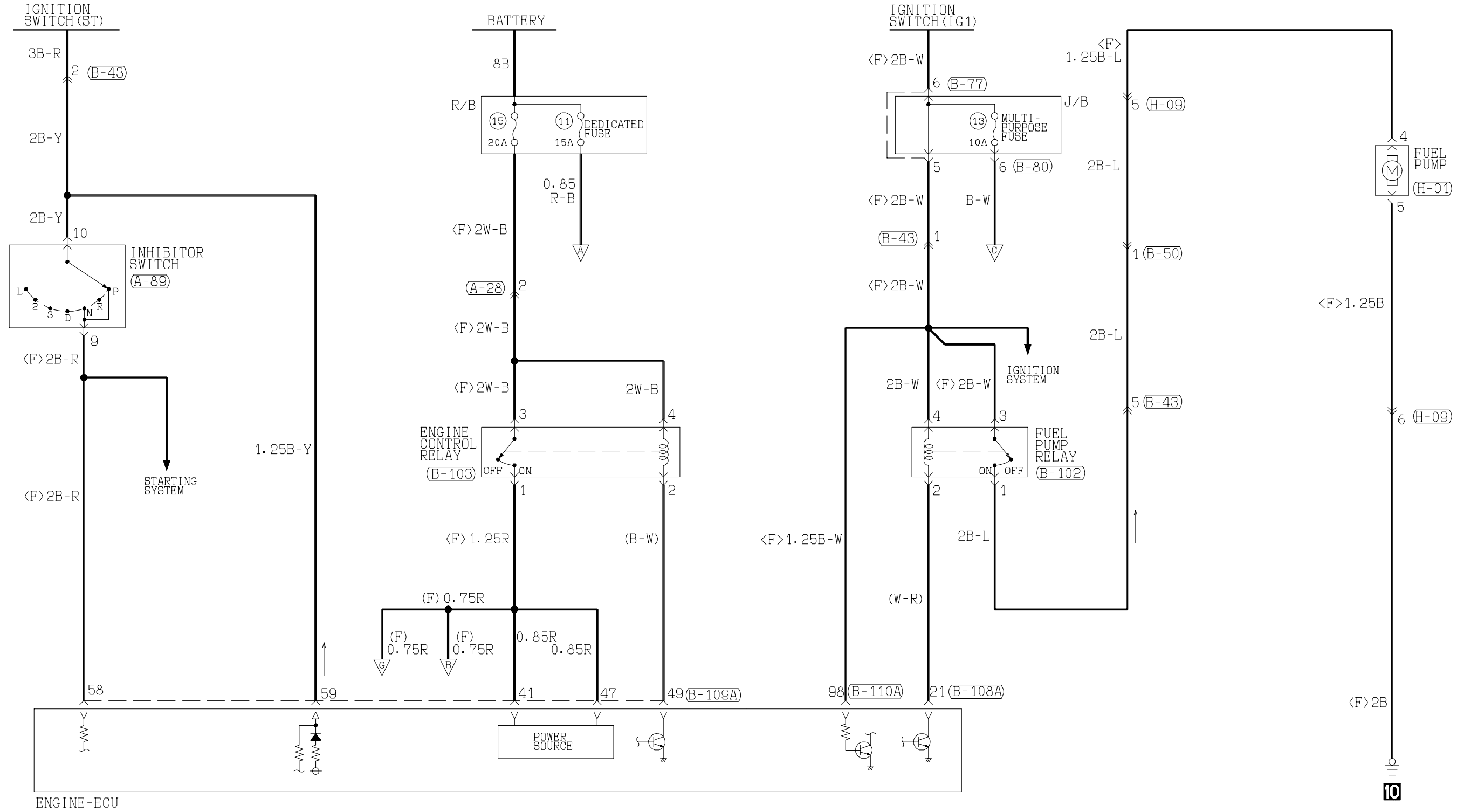

<b>B-43</b>	<b>A-89</b>	<b>B-103</b>	<b>A-28</b>	<b>B-109A</b>	<b>B-108A</b>	<b>B-43</b>	<b>B-102</b>	<b>B-50</b>	<b>H-09</b>	<b>H-01</b>
1 2 3 4 5 6	1 2 3 4 5 6 7 8 9 10	1 2 3 4	1 2 3 4 5 6 7 8 9 10	41 42 43 JAE 44 45 46 47 48 49 50 51 52 53 54 55 56 57 58 59 60 61 62 63 64 65 66	1 2 3 4 JAE 5 6 7 8 9 10 11 12 13 14 15 16 17 18 19 20 21 22 23 24 25 26 27 28 29 30 31 32 33 34 35	1 2 3 4 5 6	1 2 3 4	1 2 3 4 5 6 7 8 9 10	1 2 3 4 5 6	1 2 3 4 5 6
					<b>B-77</b>	<b>B-80</b>	<b>B-110A</b>			
					1 2 3 4 5 6	1 2 3 4 5 6 7 8 9 10 11 12 13 14 15 16 17 18 19 20	71 72 73 74 JAE 75 76 77 78 79 80 81 82 83 84 85 86 87 88 89 90 91 92 93 94 95 96 97 98			

MPI SYSTEM <Automatic Transmission Vehicles> (CONTINUED)

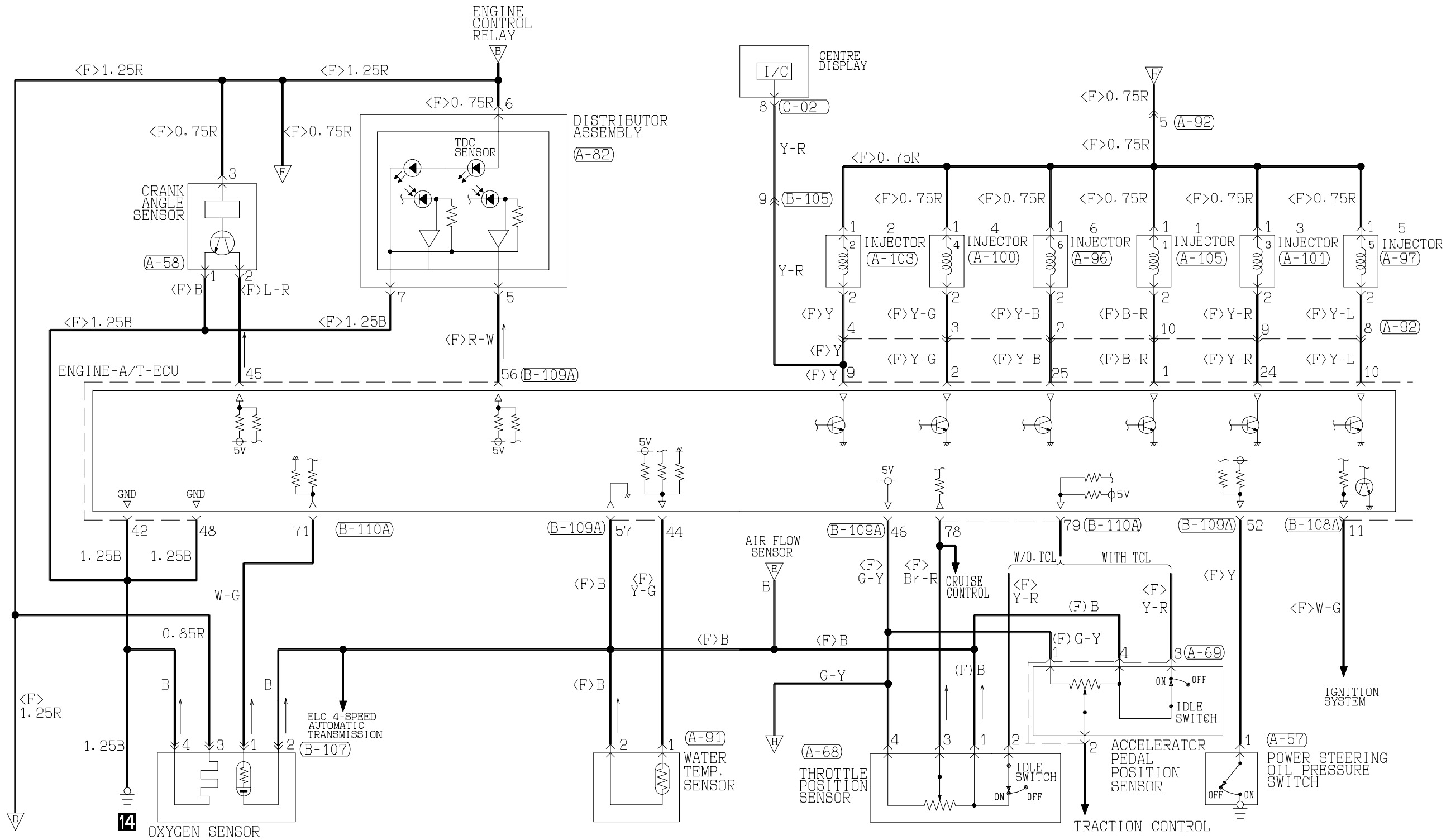

<b>(A-58)</b> 1 2 3	<b>(A-91)</b> 1 2	<b>(B-107)</b> 1 2 3 4	<b>(B-109A)</b> 41 42 43 JAE 44 45 46 47 48 49 50 51 52 53 54 55 56 57 58 59 60 61 62 63 64 65 66	<b>(B-110A)</b> 71 72 73 74 JAE 75 76 77 78 79 80 81 82 83 84 85 86 87 88 89 90 91 92 93 94 95 96 97 98	<b>(B-107)</b> 1 2 3 4	<b>(A-82)</b> 1 2 3 4 5 6 7	<b>(A-92)</b> 1 2 3 4 5 6 7 8 9 10	<b>(A-57)</b> 1 2	<b>(A-103)</b> 1 2	<b>(A-100)</b> 1 2	<b>(A-96)</b> 1 2	<b>(A-105)</b> 1 2	<b>(A-101)</b> 1 2	<b>(A-97)</b> 1 2	<b>(B-108A)</b> 1 2 3 4 JAE 5 6 7 8 9 10 11 12 13 14 15 16 17 18 19 20 21 22 23 24 25 26 27 28 29 30 31 32 33 34 35	<b>(A-68)</b> 1 2 3 4
<b>(B-109A)</b> 41 42 43 JAE 44 45 46 47 48 49 50 51 52 53 54 55 56 57 58 59 60 61 62 63 64 65 66	<b>(B-110A)</b> 71 72 73 74 JAE 75 76 77 78 79 80 81 82 83 84 85 86 87 88 89 90 91 92 93 94 95 96 97 98	<b>(A-69)</b> 1 2 3 4	<b>(B-105)</b> 1 2 3 4 5 6 7 8	<b>(C-02)</b> 1 2 3 4 5 6 7 8 9 10 11 12 13 14 15 16 17 18 19 20												

Main Index  
54 Index  
54C 08/01  
A  
B  
C  
D  
E  
F  
G  
H  
J  
K

Main Index  
54 Index  
54C 08/01  
A  
B  
C  
D  
E  
F  
G  
H  
J  
K

MPI SYSTEM <Automatic Transmission Vehicles> (CONTINUED)

- Main Index
- 54 Index
- 54C 08/01
- A
- B
- C
- D
- E
- F
- G
- H
- J
- K

- Main Index
- 54 Index
- 54C 08/01
- A
- B
- C
- D
- E
- F
- G
- H
- J
- K

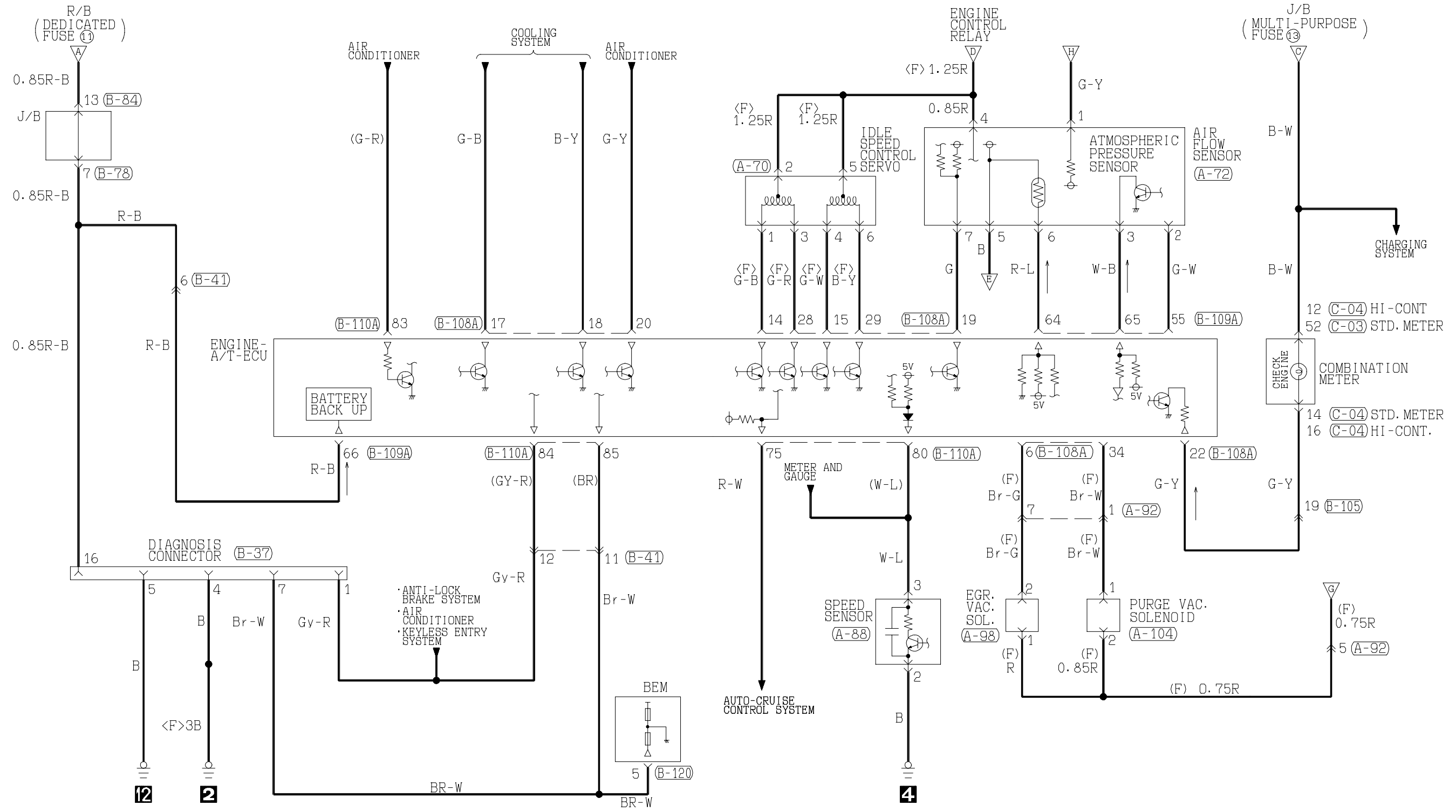

<b>(B-78)</b> 1 2 3 4 5 6 7 8 9 10	<b>(B-84)</b> 1 2 3 4 5 6 7 8 9 10 11 12 13 14 15 16 17 18	<b>(B-108A)</b> 1 2 3 4 JAE 5 6 7 8 9 10 11 12 13 14 15 16 17 18 19 20 21 22 23 24 25 26 27 28 29 30 31 32 33 34 35	<b>(B-109A)</b> 41 42 43 JAE 44 45 46 47 48 49 50 51 52 53 54 55 56 57 58 59 60 61 62 63 64 65 66	<b>(B-110A)</b> 71 72 73 74 JAE 75 76 77 78 79 80 81 82 83 84 85 86 87 88 89 90 91 92 93 94 95 96 97 98	<b>(A-70)</b> 1 2 3 4 5 6	<b>(B-105)</b> 1 2 3 4 5 6 7 8 9 10 11 12 13 14 15 16 17 18 19 20	<b>(A-72)</b> 1 2 3 4 5 6 7 8	<b>(A-88)</b> 1 2 3	<b>(C-04)</b> 1 2 3 4 5 6 7 8	<b>(C-03)</b> 41 42 43 44 45 46 47 48 49 50 51 52 53 54 55 56	<b>(B-108A)</b> 1 2 3 4 JAE 5 6 7 8 9 10 11 12 13 14 15 16 17 18 19 20 21 22 23 24 25 26 27 28 29 30 31 32 33 34 35
<b>(B-37)</b> 1 2 3 4 5 6 7 8 9 10 11 12 13 14 15 16	<b>(B-41)</b> 1 2 3 4 5 6 7 8 9 10 11 12 13 14 15 16 17 18 19 20 21 22	<b>(B-120)</b> 1 2 3 4 5 6 7 8	<b>(B-109A)</b> 41 42 43 JAE 44 45 46 47 48 49 50 51 52 53 54 55 56 57 58 59 60 61 62 63 64 65 66	<b>(B-110A)</b> 71 72 73 74 JAE 75 76 77 78 79 80 81 82 83 84 85 86 87 88 89 90 91 92 93 94 95 96 97 98	<b>(A-98)</b> 1 2	<b>(A-104)</b> 1 2	<b>(A-92)</b> 1 2 3 4 5 6 7 8 9 10				

# ELC 4-SPEED AUTOMATIC TRANSMISSION <VERADA> ELC 5-SPEED AUTOMATIC TRANSMISSION <SPORTS>

Main Index

54 Index

54C 08/01

A

B

C

D

E

F

G

H

J

K

Main Index

54 Index

54C 08/01

A

B

C

D

E

F

G

H

J

K

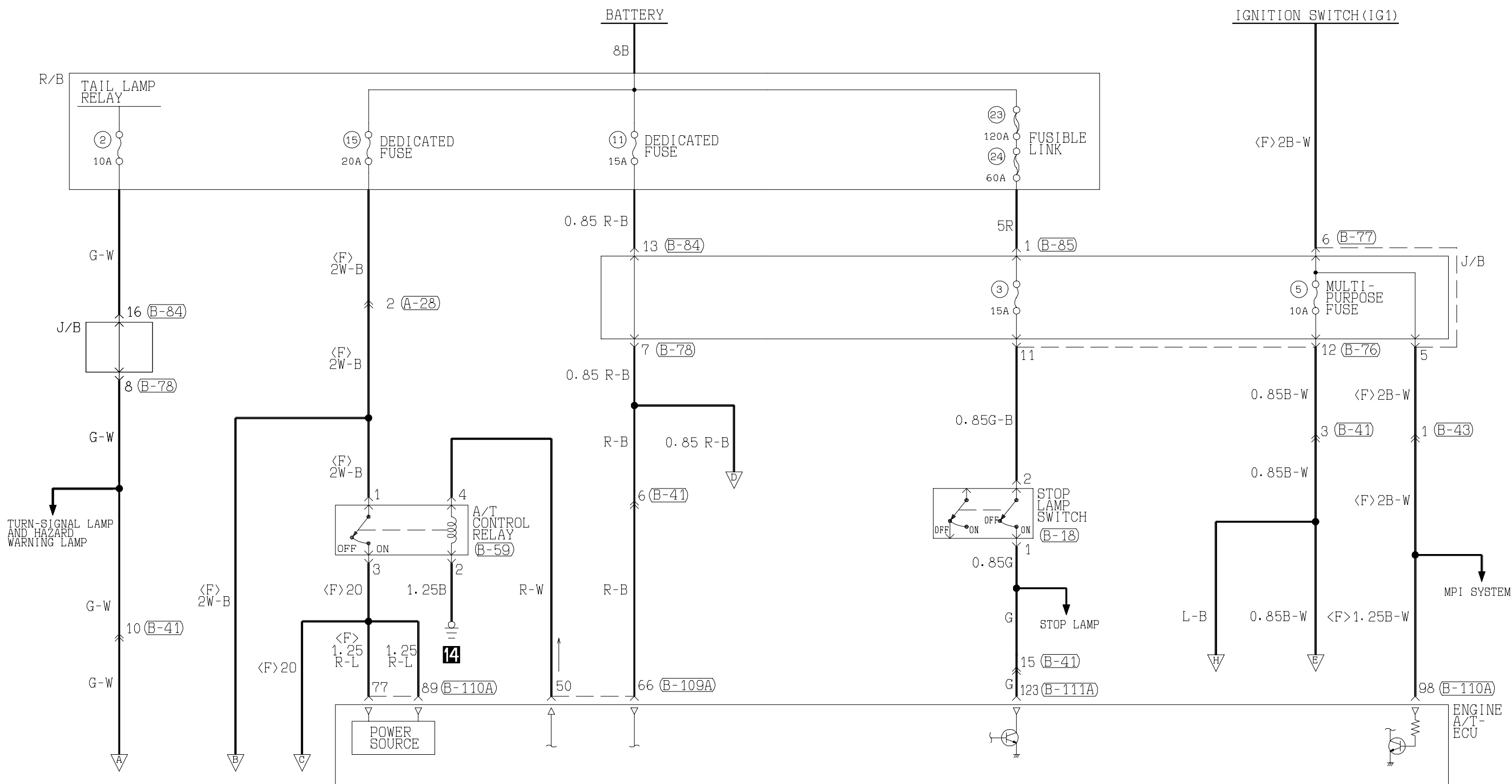

(B-78)

1	2	3	4
5	6	7	8
9	10	11	12

(B-84)

1	2	3	4	5	6	7	8
9	10	11	12	13	14	15	16
17	18	19	20	21	22	23	24

(B-109A)

41	42	43	JAE	44	45	46
47	48	49	50	51	52	53
54	55	56	57	58	59	60
61	62	63	64	65	66	67
68	69	70	71	72	73	74

(A-28)

1	2	3	4	5
6	7	8	9	10

(B-41)

1	2	3	4	5	6	7	8	9	10
11	12	13	14	15	16	17	18	19	20
21	22	23	24	25	26	27	28	29	30

(B-110A)

71	72	73	74	JAE	75	76	77
78	79	80	81	82	83	84	85
86	87	88	89	90	91	92	93
94	95	96	97	98	99	100	101
102	103	104	105	106	107	108	109
110	111	112	113	114	115	116	117
118	119	120	121	122	123	124	125
126	127	128	129	130	131	132	133

(B-111A)

101	102	103	104	JAE	105	106	107
108	109	110	111	112	113	114	115
116	117	118	119	120	121	122	123
124	125	126	127	128	129	130	131

(B-41)

1	2	3	4	5	6	7	8	9	10
11	12	13	14	15	16	17	18	19	20
21	22	23	24	25	26	27	28	29	30

(B-43)

1	2
3	4
5	6

(B-18)

1	2
3	4

(B-85)

1
---

(B-77)

1	2
3	4
5	6

(B-110A)

71	72	73	74	JAE	75	76	77
78	79	80	81	82	83	84	85
86	87	88	89	90	91	92	93
94	95	96	97	98	99	100	101
102	103	104	105	106	107	108	109
110	111	112	113	114	115	116	117
118	119	120	121	122	123	124	125
126	127	128	129	130	131	132	133

(B-59)

1	2
3	4

(B-76)

1	2	3	4	5	6	7	8	9	10
11	12	13	14	15	16	17	18	19	20
21	22	23	24	25	26	27	28	29	30

**ELC 4-SPEED AUTOMATIC TRANSMISSION <VERADA>  
 ELC 5-SPEED AUTOMATIC TRANSMISSION <SPORTS>  
 (CONTINUED)**

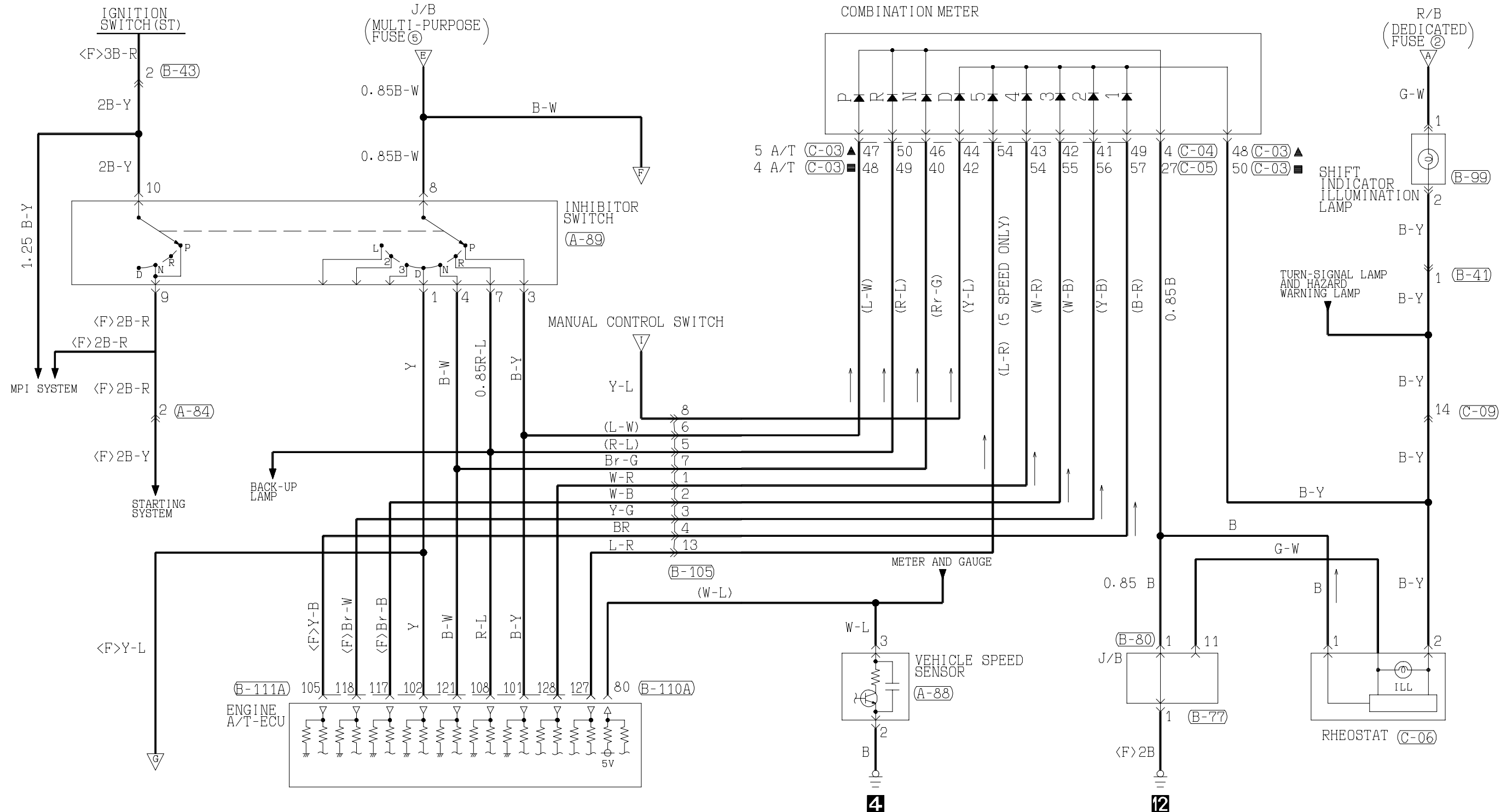

(B-105)	(B-43)	(A-89)	(A-84)	(B-110A)	(B-111A)	(A-88)	(C-04)	(C-03) ▲	(B-41)	(C-06)	(B-99)
1 2 3 4 5 6 7 8 9 10 11 12 13 14 15 16 17 18 19 20	1 2 3 4 5 6	1 2 3 4 5 6 7 8 9 10	1 2	71 72 73 74 JAE 75 76 77 78 79 80 81 82 83 84 85 86 87 88 89 90 91 92 93 94 95 96 97 98	101 102 103 104 JAE 105 106 107 108 109 110 111 112 113 114 115 116 117 118 119 120 121 122 123 124 125 126 127 128 129 130	1 2 3	1 2 3 4 5 6 7 8 9 10 11 12 13 14 15 16 17	41 42 43 44 45 46 47 48 49 50 51 52 53 54 55 56	1 2 3 4 5 6 7 8 9 10 11 12 13 14 15 16 17 18 19 20 21 22	1 2 3	1 2
(C-09)	(B-77)	(B-80)	(C-03) ■	(C-05)							
1 2 3 4 5 6 7 8 9 10 11 12 13 14 15 16 17 18 19 20 21 22	1 2 3 4 5 6	1 2 3 4 5 6 7 8 9 10 11 12 13 14 15 16 17 18 19 20	38 39 40 41 42 43 44 45 46 47 48 49 50 51 52 53 54 55 56 57	21 22 23 24 25 26 27 28 29							

Main Index  
 54 Index  
 54C 08/01  
 A  
 B  
 C  
 D  
 E  
 F  
 G  
 H  
 J  
 K

Main Index  
 54 Index  
 54C 08/01  
 A  
 B  
 C  
 D  
 E  
 F  
 G  
 H  
 J  
 K

# ELC 4-SPEED AUTOMATIC TRANSMISSION <VERADA> ELC 5-SPEED AUTOMATIC TRANSMISSION <SPORTS> (CONTINUED)

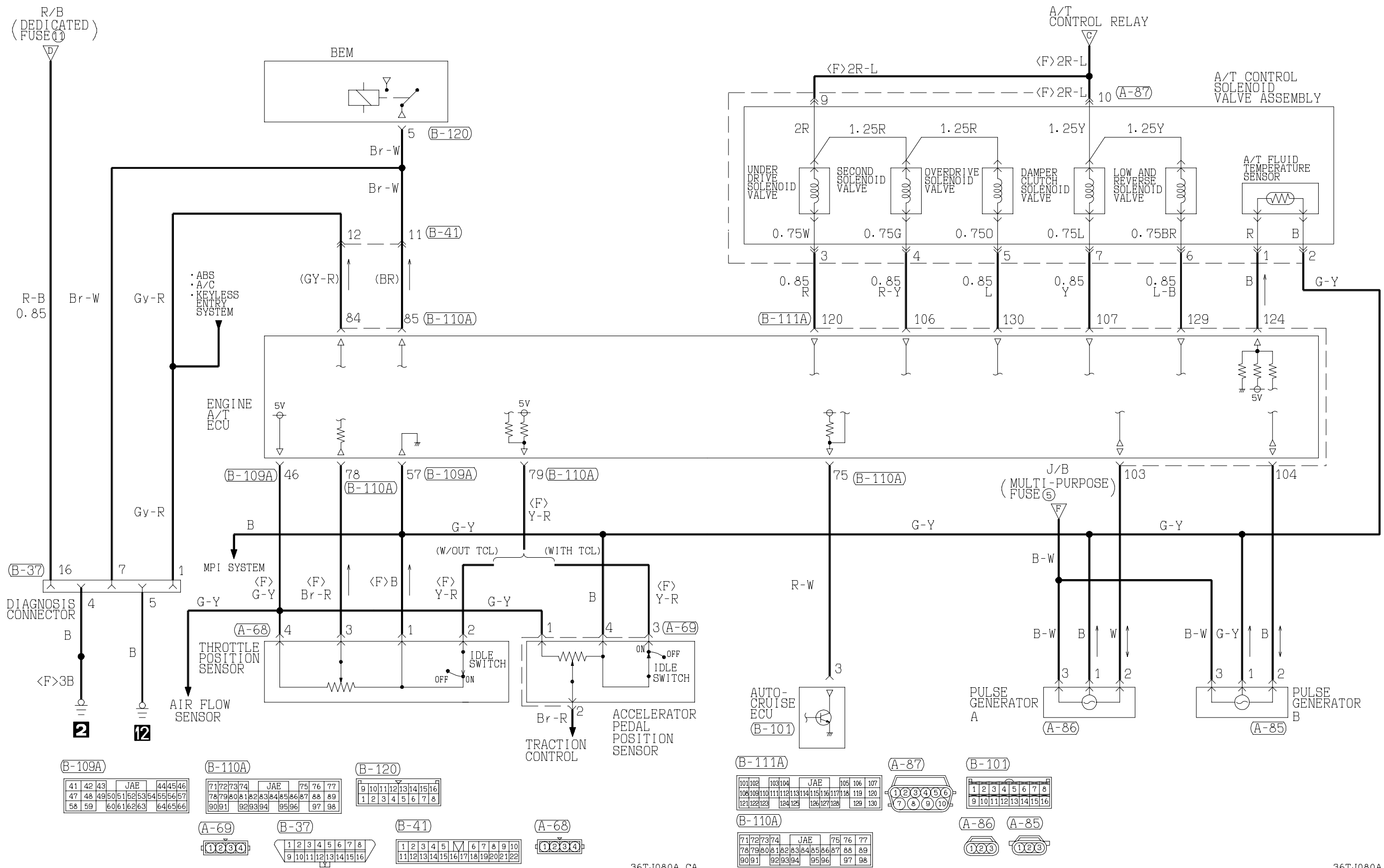

(B-109A)

41	42	43	JAE	44	45	46
47	48	49	50	51	52	53
54	55	56	57	58	59	60
61	62	63	64	65	66	

(B-110A)

71	72	73	74	JAE	75	76	77
78	79	80	81	82	83	84	85
86	87	88	89	90	91	92	93
94	95	96	97	98			

(B-120)

9	10	11	12	13	14	15	16
1	2	3	4	5	6	7	8

(A-69)

1	2	3	4
---	---	---	---

(B-37)

1	2	3	4	5	6	7	8
9	10	11	12	13	14	15	16

(B-41)

1	2	3	4	5	6	7	8	9	10
11	12	13	14	15	16	17	18	19	20
21	22								

(A-68)

1	2	3	4
---	---	---	---

(B-111A)

101	102	103	104	JAE	105	106	107
108	109	110	111	112	113	114	115
116	117	118	119	120	121	122	123
124	125	126	127	128	129	130	

(A-87)

1	2	3	4	5	6
7	8	9	10		

(B-101)

1	2	3	4	5	6	7	8
9	10	11	12	13	14	15	16

(B-110A)

71	72	73	74	JAE	75	76	77
78	79	80	81	82	83	84	85
86	87	88	89	90	91	92	93
94	95	96	97	98			

(A-86)

1	2	3
---	---	---

(A-85)

1	2	3
---	---	---

Main Index  
 54 Index  
 54C 08/01  
 A  
 B  
 C  
 D  
 E  
 F  
 G  
 H  
 J  
 K

Main Index  
 54 Index  
 54C 08/01  
 A  
 B  
 C  
 D  
 E  
 F  
 G  
 H  
 J  
 K

**ELC 4-SPEED AUTOMATIC TRANSMISSION <VERADA>  
 ELC 5-SPEED AUTOMATIC TRANSMISSION <SPORTS>  
 (CONTINUED)**

Main Index  
 54 Index  
 54C 08/01  
 A  
 B  
 C  
 D  
 E  
 F  
 G  
 H  
 J  
 K

Main Index  
 54 Index  
 54C 08/01  
 A  
 B  
 C  
 D  
 E  
 F  
 G  
 H  
 J  
 K

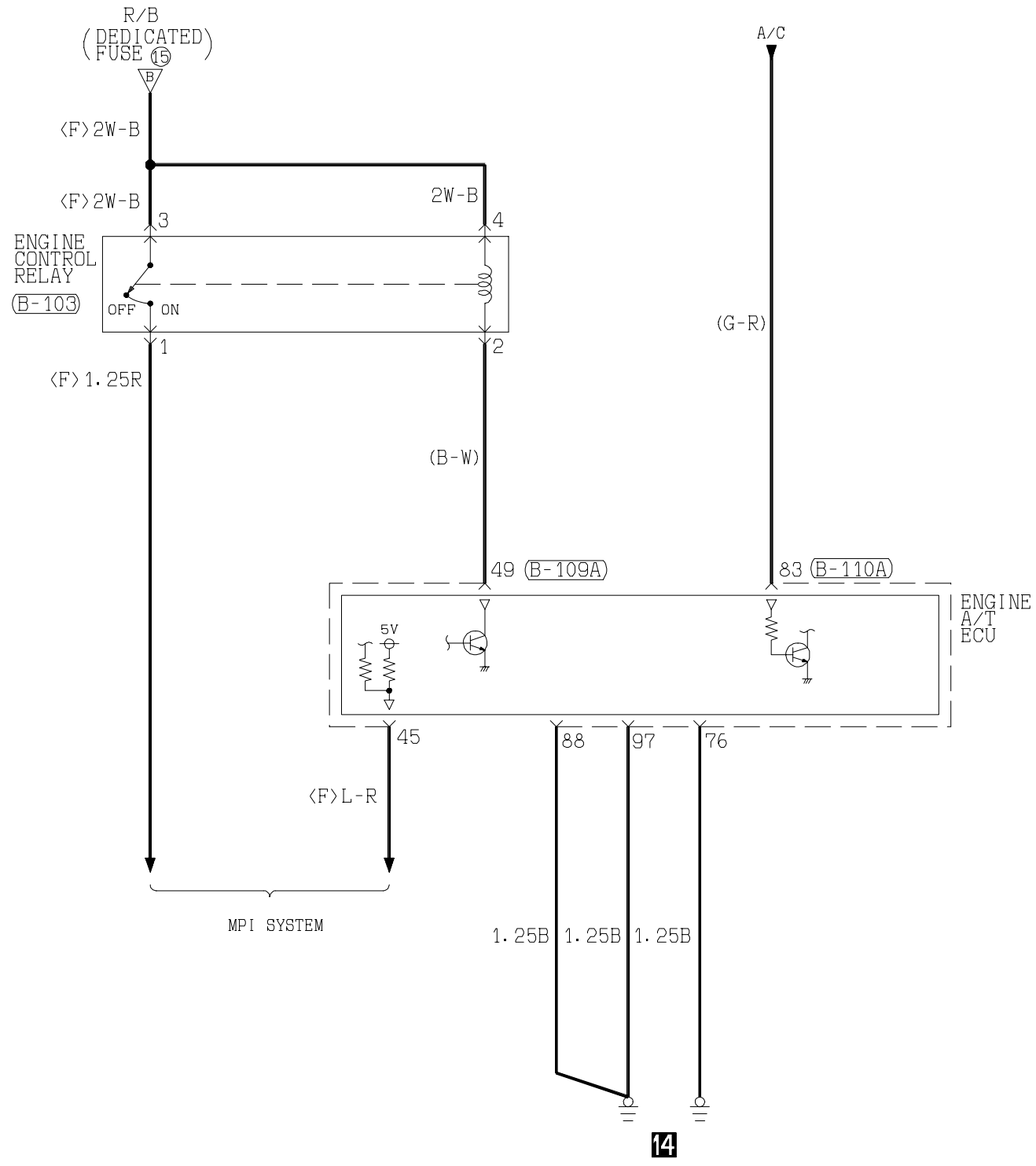

B-109A				B-110A				B-103									
41	42	43	JAE	44	45	46	71	72	73	74	JAE	75	76	77	1	2	
47	48	49	50	51	52	53	54	55	56	57	78	79	80	81	82	3	4
58	59	60	61	62	63	64	65	66	90	91	92	93	94	95	96	97	98

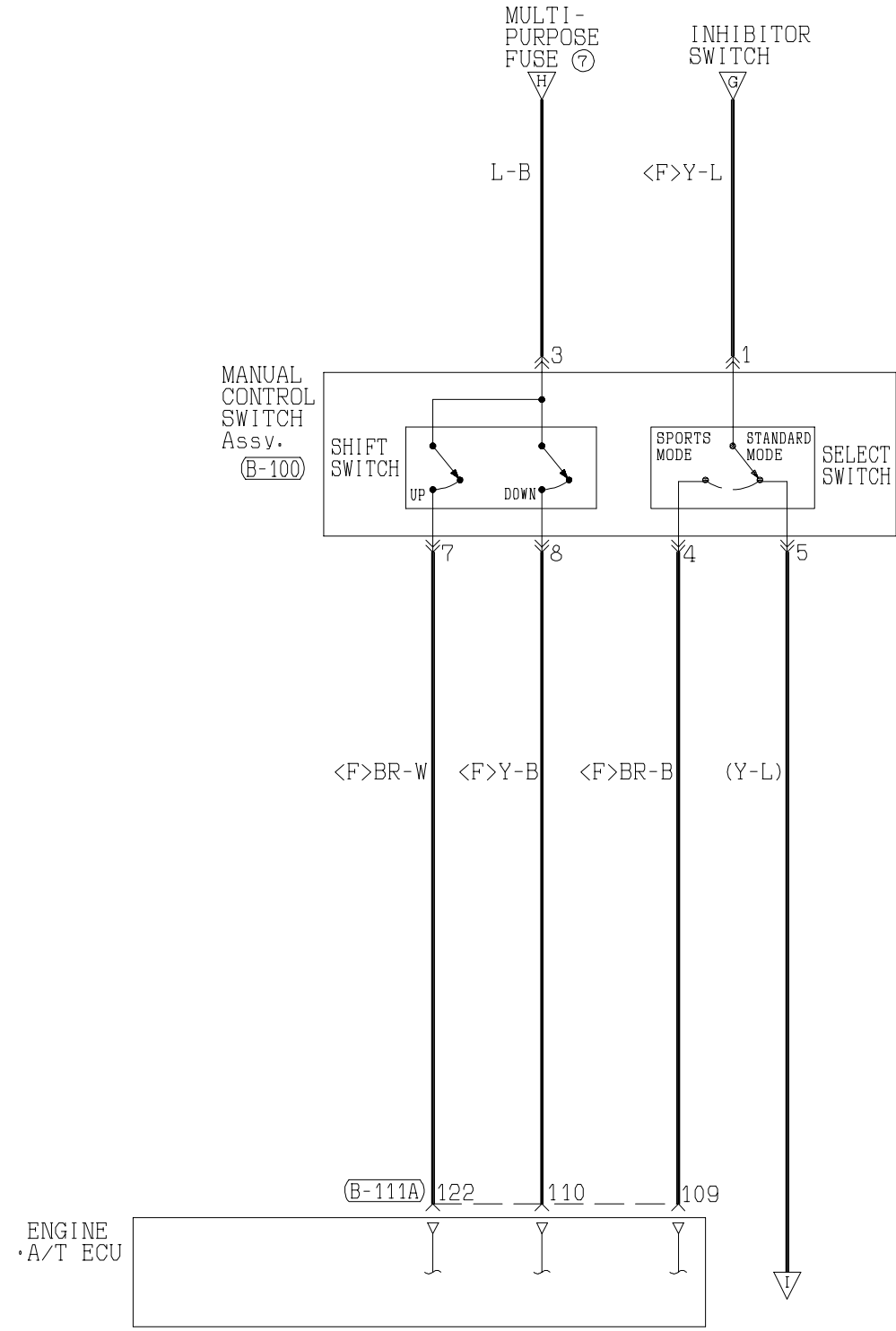

B-111A										B-100					
101	102	103	104	JAE	105	106	107	1	2	3	4	5	6	7	8
108	109	110	111	112	113	114	115	116	117	118	119	120	121	122	123
124	125	126	127	128	129	130									





FOG LAMP <VERADA AND SPORTS>

Main Index

54 Index

54C 08/01

A

B

C

D

E

F

G

H

J

K

Main Index

54 Index

54C 08/01

A

B

C

D

E

F

G

H

J

K

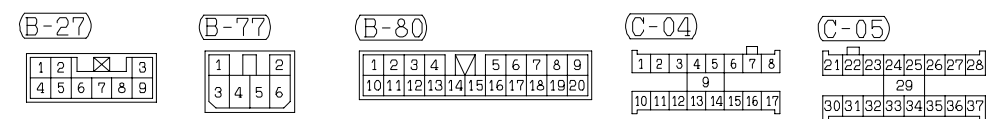
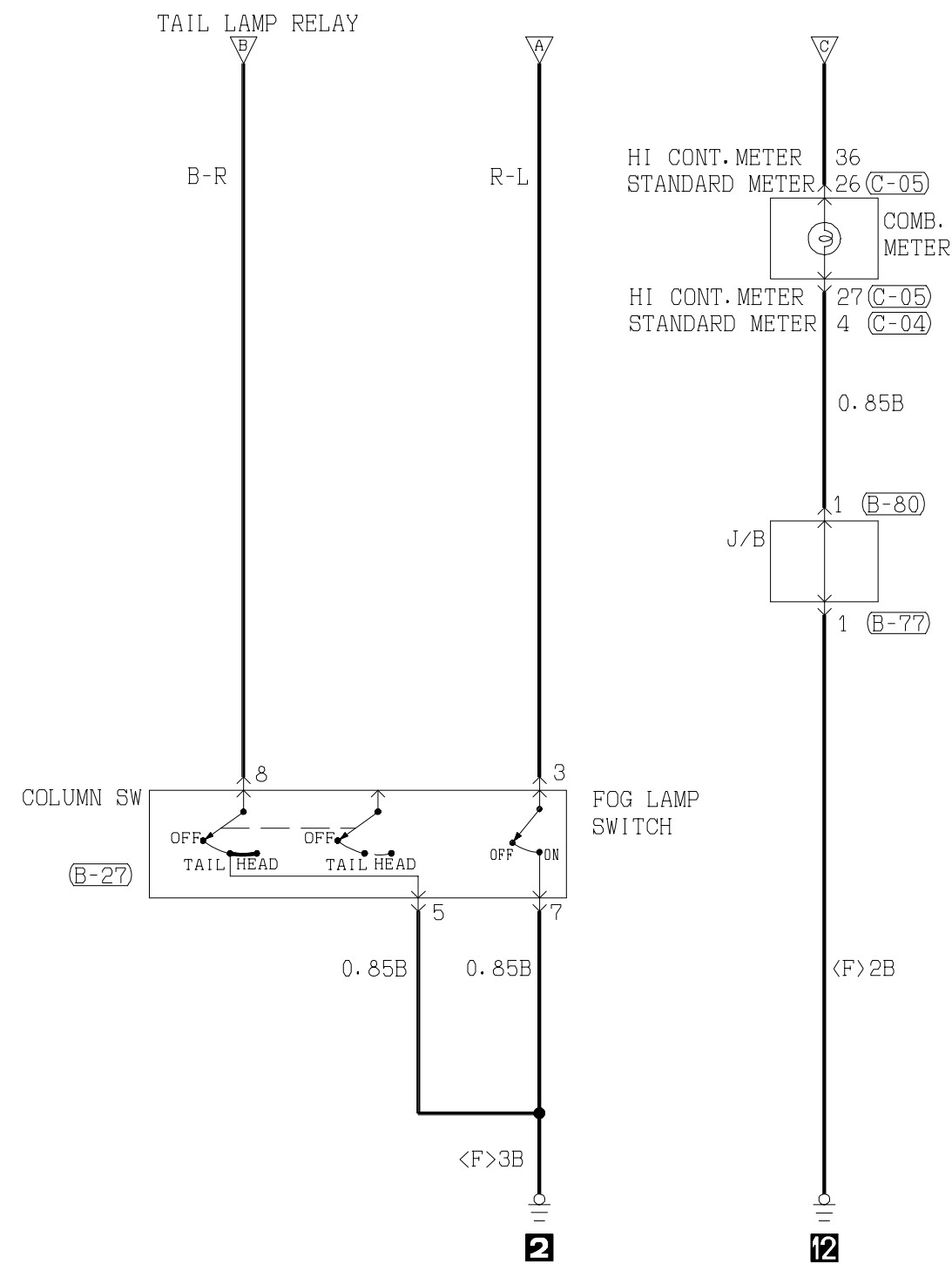
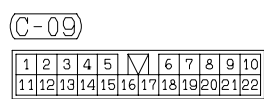
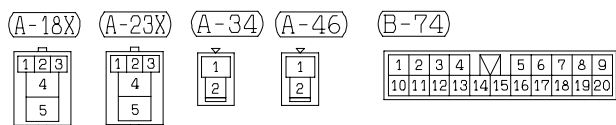
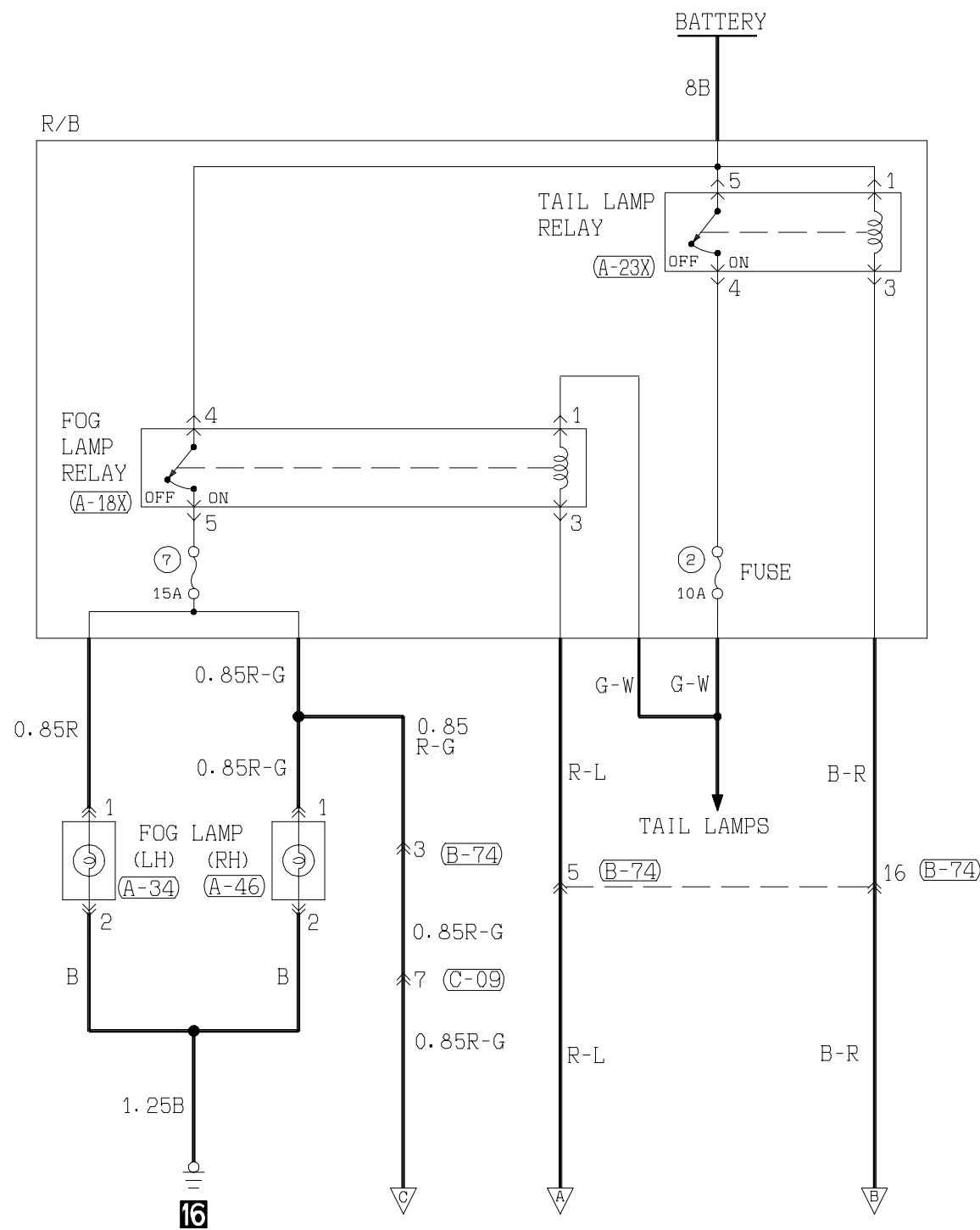

# DOOR LAMP AND FOOT LAMP

Main Index

54 Index

54C 08/01

A

B

C

D

E

F

G

H

J

K

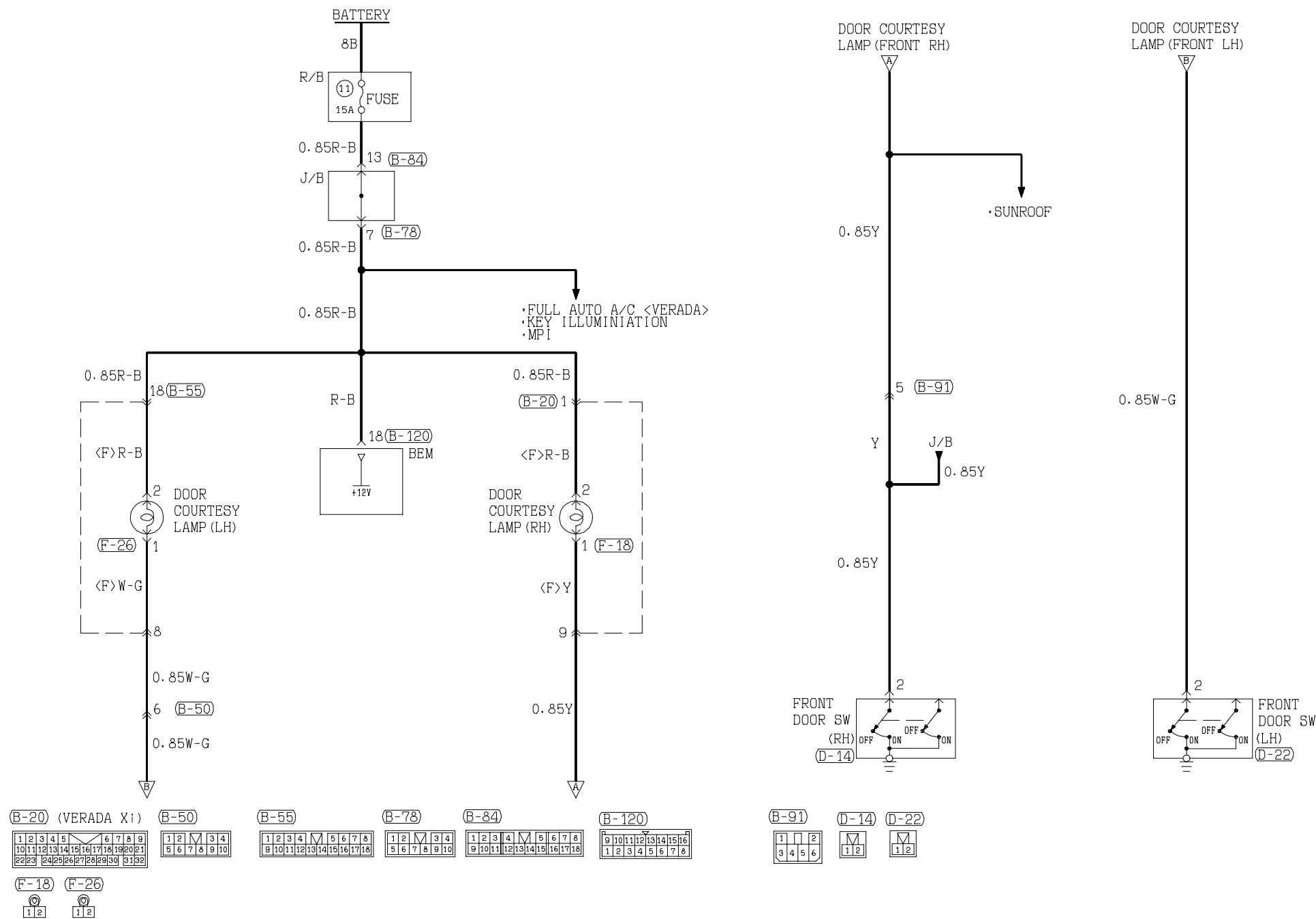

Main Index

54 Index

54C 08/01

A

B

C

D

E

F

G

H

J

K

# IGNITION KEY CYLINDER LAMP

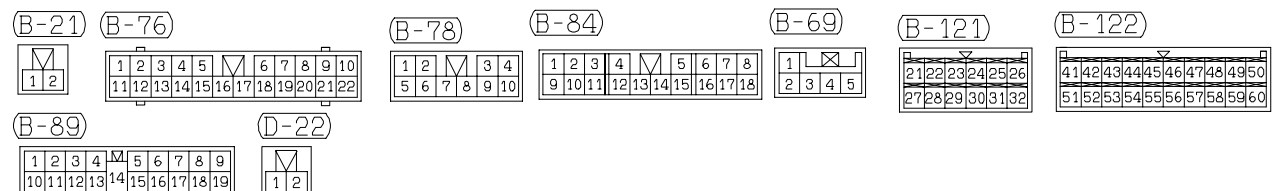
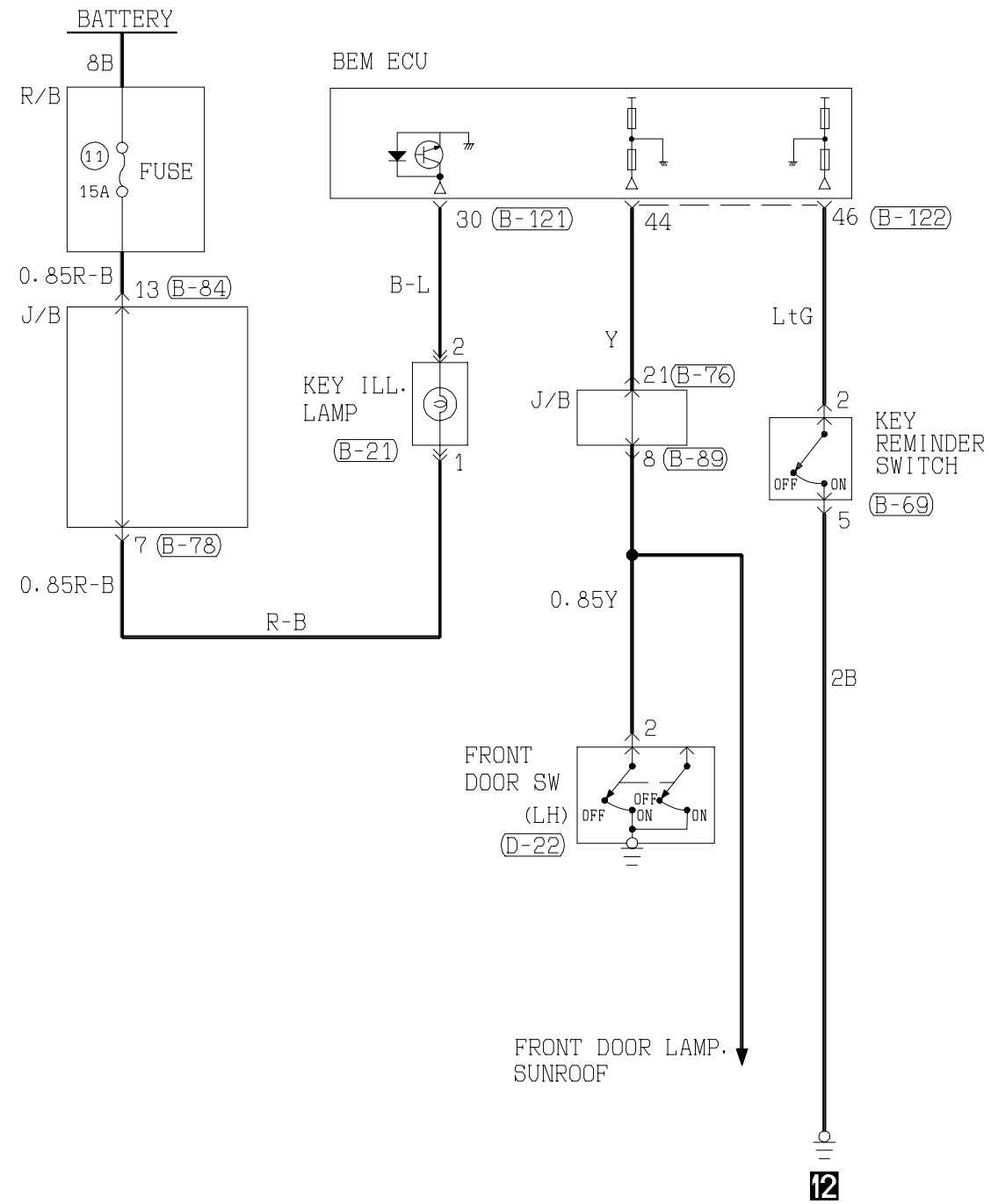

Main Index

54 Index

54C 08/01

A

B

C

D

E

F

G

H

J

K

Main Index

54 Index

54C 08/01

A

B

C

D

E

F

G

H

J

K

STOP LAMP <SEDAN>

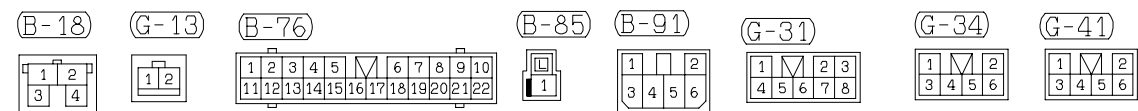
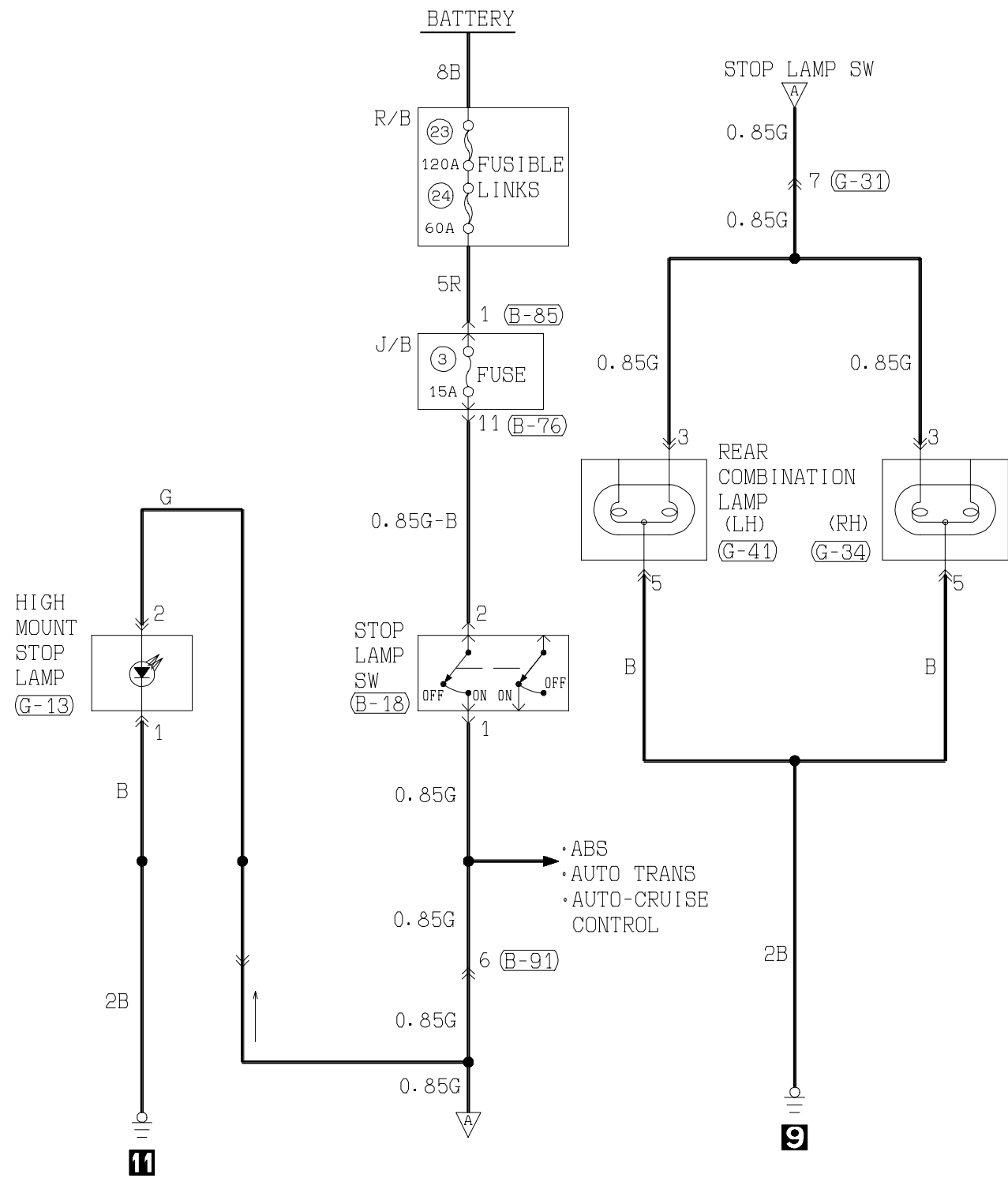

METER <Standard Meter>

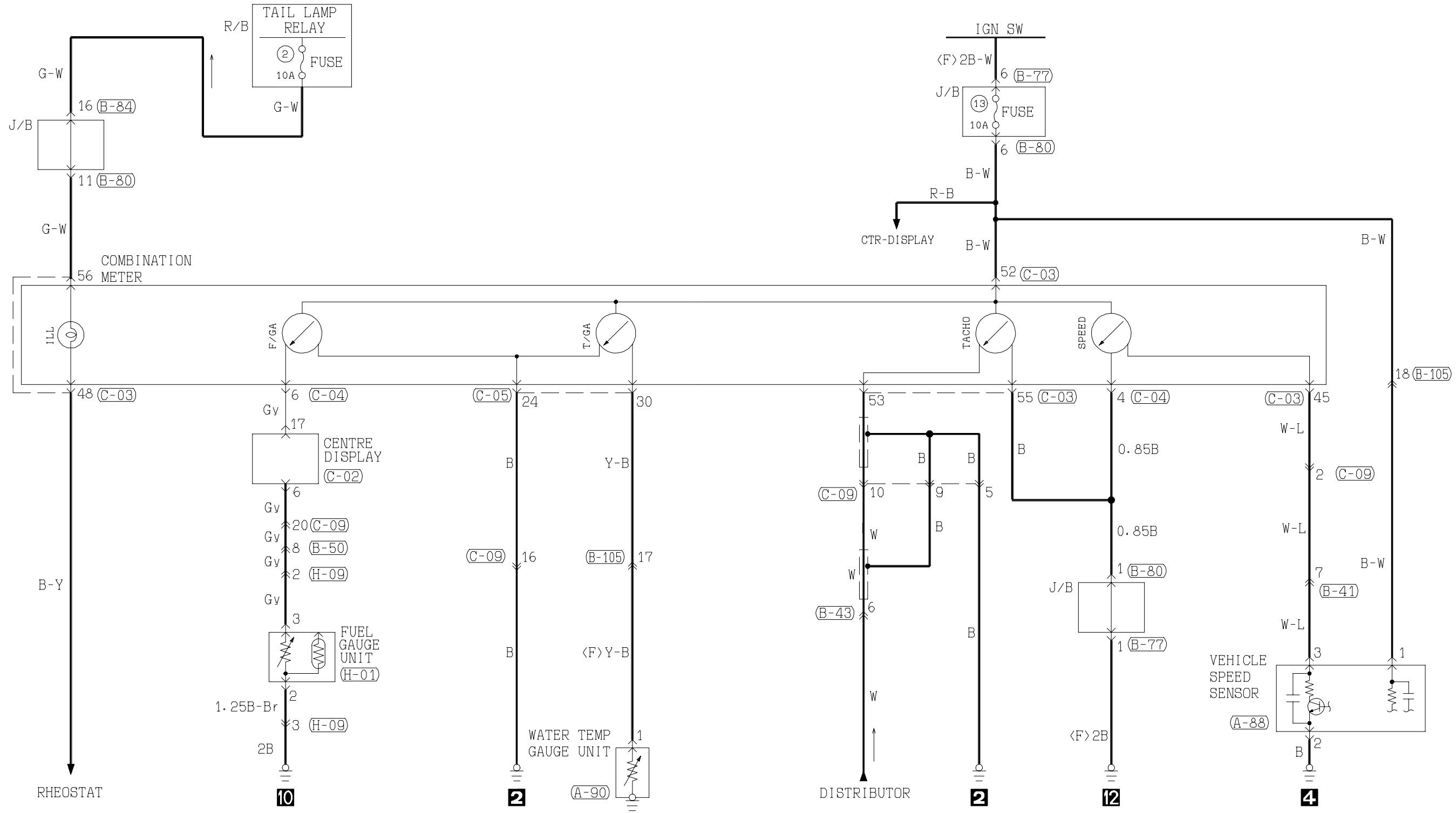

(A-90)	(B-50)	(B-105)	(B-80)	(B-84)	(H-09)	(C-02)	(B-41)	(B-105)	(B-43)	(B-77)	(B-80)
1	1 2 3 4 5 6 7 8 9 10	1 2 3 4 5 6 7 8 9 10 11 12 13 14 15 16 17 18 19 20	1 2 3 4 5 6 7 8 9 10 11 12 13 14 15 16 17 18 19 20	1 2 3 4 5 6 7 8 9 10 11 12 13 14 15 16 17 18	1 2 3 4 5 6	1 2 3 4 5 6 7 8 9 10 11 12 13 14 15 16 17 18 19 20	1 2 3 4 5 6 7 8 9 10 11 12 13 14 15 16 17 18 19 20 21 22	1 2 3 4 5 6 7 8 9 10 11 12 13 14 15 16 17 18 19 20	1 2 3 4 5 6 3 4 5 6	1 2 3 4 5 6 3 4 5 6	1 2 3 4 5 6 7 8 9 10 11 12 13 14 15 16 17 18 19 20
(C-03)	(C-04)	(C-05)	(C-09)	(H-01)			(A-88)	(C-03)	(C-04)	(C-09)	
41 42 43 44 45 46 47 48 49 50 51 52 53 54 55 56	1 2 3 4 5 6 7 8 9	21 22 23 24 25 26 27 28 29	1 2 3 4 5 6 7 8 9 10 11 12 13 14 15 16 17 18 19 20 21 22	1 2 3 4 5			1 2 3 4 1 42 43 44 45 46 47 48 49 50 51 52 53 54 55 56	1 2 3 4 5 6 7 8 9	1 2 3 4 5 6 7 8 9 10 11 12 13 14 15 16 17 18 19 20 21 22		

Main Index  
54 Index  
54C 08/01  
A  
B  
C  
D  
E  
F  
G  
H  
J  
K

Main Index  
54 Index  
54C 08/01  
A  
B  
C  
D  
E  
F  
G  
H  
J  
K

METER <High Contrast Meter>

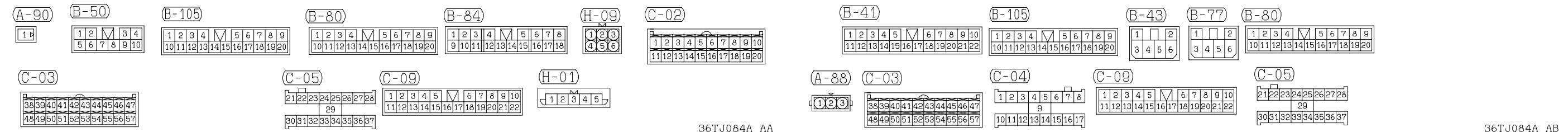
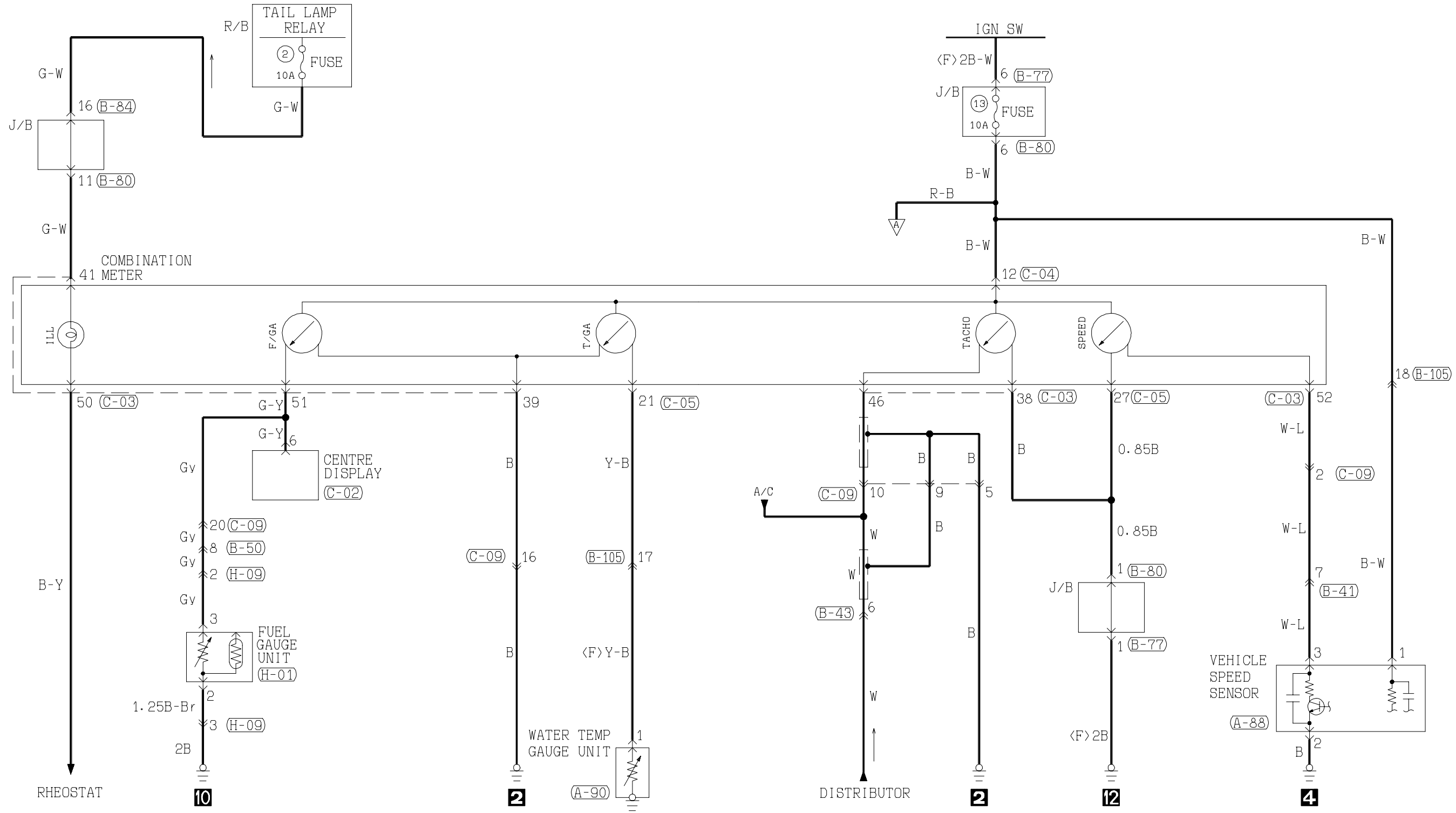

Main Index

54 Index

54C 08/01

A

B

C

D

E

F

G

H

J

K

Main Index

54 Index

54C 08/01

A

B

C

D

E

F

G

H

J

K