

Fuses and relays

PASSENGER COMPARTMENT FUSE AND RELAY BOX (260)

location

This unit is located in the passenger compartment, in the lower left-hand section of the dashboard.

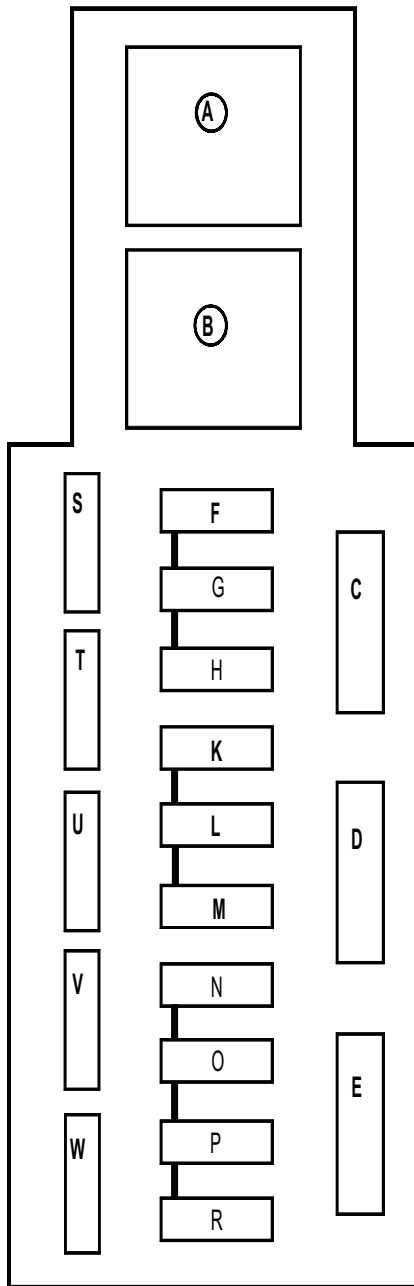



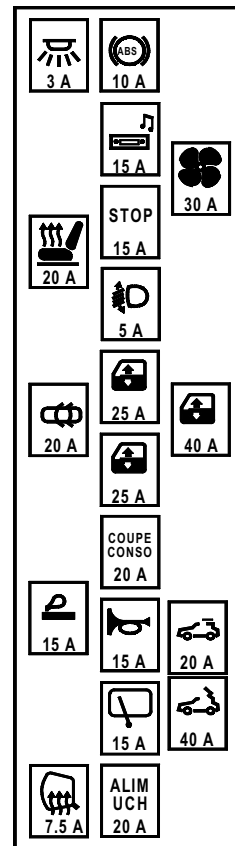







SE2158







SE2212

Fuses and relays

Allocation of fuses and relays (according to equipment level)

No.	Symbol	Amps	Connection	Description
C		30A	SP3	Fuse: passenger compartment ventilation (319)
D		40A	BP87 or BP48	Fuse: rear electric windows (201-202) or electric windows relay (703).
E	 	20A	BP93	Fuse: electric sunroof (304) on K84 and L84
		or 40A	BP51	Fuse: sunroof hydraulic unit relay (1487) on E84
F		10A	SP15	Fuse: ABS computer (118) or Electronic Stability Program (1094)
G		15A	SP2	Fuse: radio (261)- multifunction display (653)- headlight washer pump relay (753)- headlight washer pump relay 2 (1338)- first row cigarette lighter on K84 and L84 (101)- driver and passenger heated seat (385-386)- bi-directional windscreen and rear screen washer pump (677)- diesel heater relay (450 via 1337)- air conditioning control panel (319)- air conditioning control unit (419)- rigid retractable roof computer on E84 (1476)- return sensor on E84 (1545)- interior rear-view mirror on E84 (1340)- Central communication unit (1125)- Central alarm unit (427)-
H	STOP	15A	SP17	Fuse: brake lights (160-1524)
K		--	--	Not in use
L		25A	BP55	Fuse: driver's electric window (203)
M		25A	BP70	Fuse: passenger electric window (204) - electric windows relay (703).
N	COUPE CONSO	20A	BCP3	Fuse: consumer cut-out - instrument panel (247) - radio (261) - multifunction display (653) - electric door mirror switch (134) - alarm control unit (427)
O		15A	BP32	Fuse: main electromagnetic horn (105) - diagnostic socket (225) - headlight washer pump relay (753) - headlight washer pump relay 2 (1338) - rigid retractable roof computer on E84 (1476) - driving school monitor control (469)
P		15A	BP25	Fuse: rear screen wiper motor on K84 (211)
R	ALIM UCH	20A	BP77	Fuse: UCH(645) air conditioning control unit (419)- accessories relay 1 (1155) (on relay plate 260 mark B)
S		3A	AP1A	On K84 and L84

Fuses and relays

				Fuse: passenger compartment temperature sensor fan (418) - interior rear-view mirror (1340) - light and rain sensor (1415)
T		20A	BPR1	Fuse: passenger and driver's heated seat (385-386)
U		20A	BP3	Fuse: door electric locking or dead-locking (645)
V		15A	SP4G	On E84 Fuse: cigarette lighter (101)
W		7.5A	15RP	Fuse: passenger and driver's heated door mirrors (239-240)
A		40A		Relay: electric window (703)
B		40A		Relay: accessories 1 (1155)

Fuses and relays

RELAY BOARD (1173)

location

This unit is located under the dashboard on the left-hand side of the passenger compartment fan assembly.

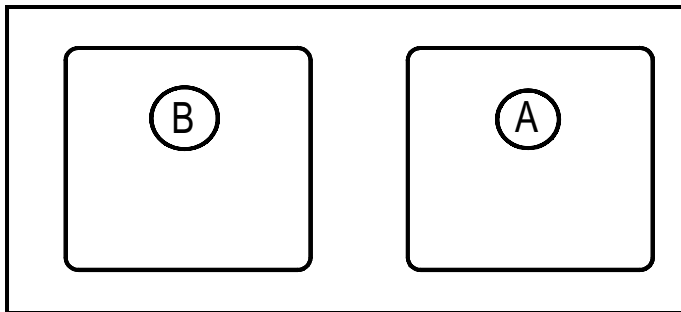

SE2187

Allocation of relays (depending on equipment level)

No.	Amps	Description
A	40A	Relay: 330W auxiliary heating 1 (1067)
B	70A	Relay: 660W auxiliary heating 2 (1068)

Fuses and relays

RELAY UNIT (1524)

location

This relay is located on the accelerator pedal mounting.

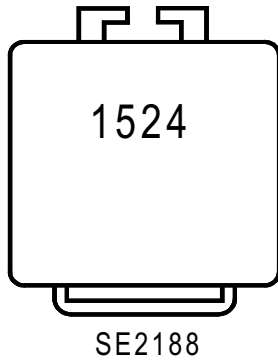

Allocation of relays (depending on equipment level)

Amps	Description
40A	Relay: brake lights lighting (1524) controlled by the ESP ECU (1094).

Fuses and relays

UCH (645)

location

This unit is located in the passenger compartment, in the lower left-hand section of the dashboard.

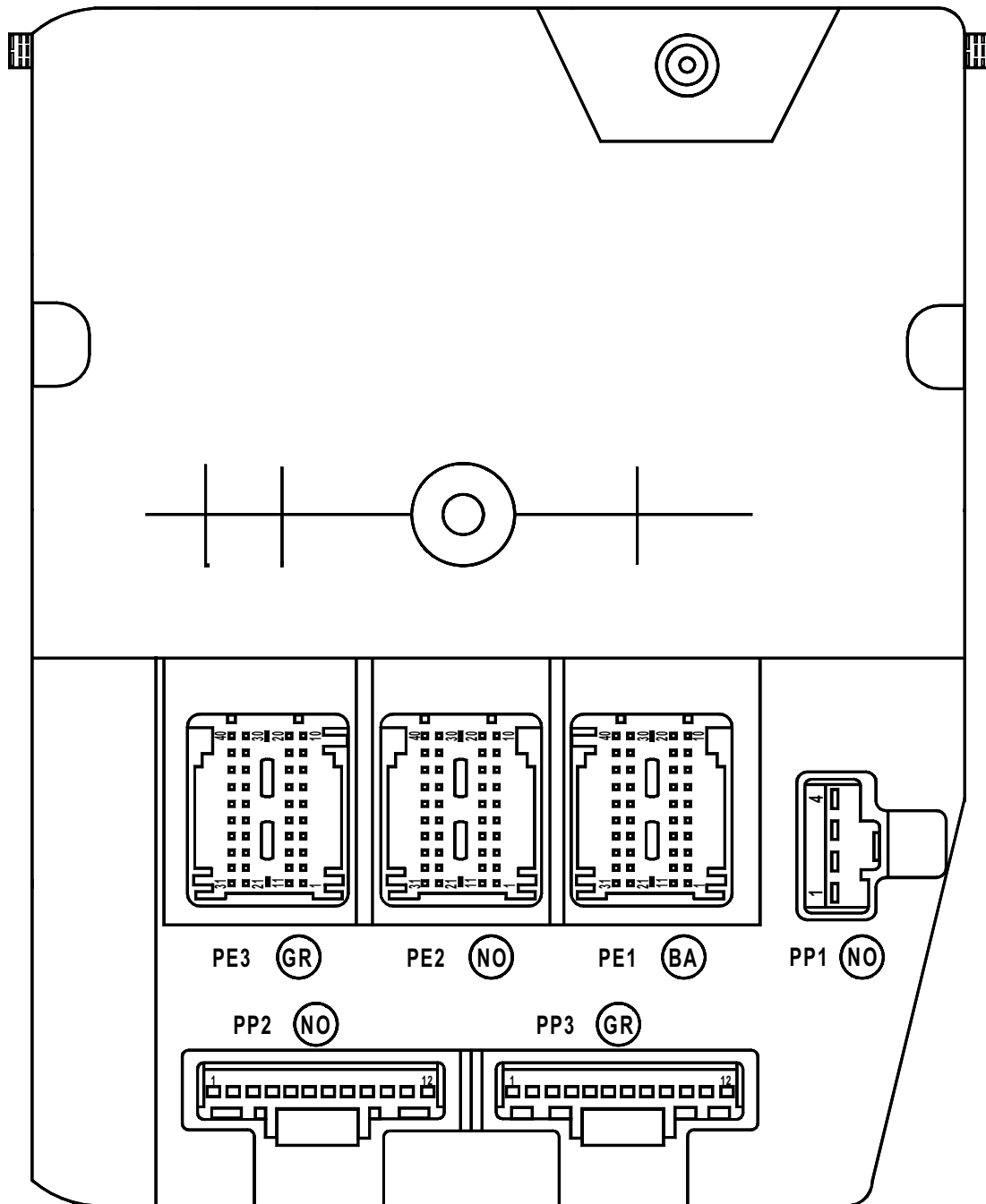

SE2160

Fuses and relays

Allocation (according to the equipment level)

PE1(40-track connector) **WHITE**

BROWN		
Track	Connection	Description
1	26J	Safety Hall sensor-control
2	47Z	External temperature / display signal
3	64F	Hazard warning lights indicator light + control feed
4	26BC	Card Location LED Control
5	26X	Clutch - signal
6	20AW	One-touch door locking/unlocking control
7	26N	Engine start/stop + signal feed
8	87T	Rear luggage compartment door position 1 switch signal
9	20T	Child safety LED - control feed
10	--	Not in use
11	20AL	Rear internal locking control
12	16A	Windscreen washer pump + control feed
13	26M	Engine running indicator light control
14	20M	Door locking LED
15	87G	Passenger position 1 switch signal
16	87B	Right-hand rear position 1 switch - signal
17	87H	Driver's position 1 signal switch
18	20BG	Rear doors deadlocking status signal
19	87A	Left-hand rear position 1 switch - signal
GREEN		
Track	Connection	Description
20	--	Not in use
21	--	Not in use
22	--	Not in use
23	--	Not in use
24	--	Not in use
25	--	Not in use
26	--	Not in use
27	--	Not in use
28	--	Not in use
29	--	Not in use
30	--	Not in use
31	--	Not in use
32	--	Not in use
33	--	Not in use
34	--	Not in use
35	--	Not in use
36	--	Not in use
37	--	Not in use
38	--	Not in use
39	--	Not in use
40	--	Not in use

Fuses and relays

Allocation (according to equipment level)

PE2(40-track connector) **BLACK**

BROWN		
Track	Connection	Description
1	14S	Rain sensor serial line signal
2	141H	Column-mounted information display control line 5 signal
3	47C	External air temperature sensor + signal feed
4	141D	Column-mounted information display control line 3 signal
5	141N	Column-mounted information display control column 4 signal
6	CANH	CAN H fault finding signal
7	21K	Anti-pinch sunroof electric window serial line signal
8	133B	Instrument panel CAN H signal > ECU
9	141K	Column-mounted information display control column 1 signal
10	26AZ	Keyless vehicle steering column lock CAN H signal
11	141G	Column-mounted information display control line 4 signal
12	141C	Column-mounted information display control line 2 signal
13	47D	External temperature sensor 0V signal
14	141B	Column-mounted information display control line 1 signal
15	141L	Column-mounted information display control column 2 signal
16	CANL	CAN L fault finding signal
17	141M	Column-mounted information display control column 3 signal
18	133C	Instrument panel CAN L signal > ECU
19	141P	Column-mounted information display control column 5 signal
20	26BA	Keyless vehicle steering column lock CAN L signal
GREEN		
Track	Connection	Description
21	26BH	+ Card reader
22	38JV	PTC (Positive Temperature Coefficient ceramic) relay control 2
23	80FD	Siren relay control (Mexico alarm)
24	15M	Heated rear screen relay - control
25	26BK	- Card reader
26	38ES	Air conditioning indicator light - control
27	65A/65G	Brake light + control / Brake light control > relay
28	24A	Rear screen washer pump + control feed
29	80T	Software lock indicator light - control
30	38LP	Air conditioning start/stop control
31	--	Not in use
32	38LQ	Fan assembly speed 0 signal
33	38JU	PTC (Positive Temperature Coefficient ceramic) relay control 1
34	S	+ Accessories feed
35	64Q	Central flasher unit timer + control feed
36	5A	Brake pedal switch + signal feed
37	36C	Rear screen wiper park position switch - signal
38	15A	Rear screen de-icing warning light control
39	26BG	Card reader / UCH data signal
40	26BD	Card reader / UCH synchronisation signal

Fuses and relays

Allocation (according to equipment level)

PE3(40-track connector) **GREY**

BROWN		
Track	Connection	Description
1	--	Not in use
2	--	Not in use
3	26P	+ Door handle infrared sensor feed
4	26AR	Level 2 keyless vehicle luggage compartment lid switch / locking signal
5	20G	Tailgate motor opening control
6	26AQ	Keyless vehicle passenger side door switch / locking signal
7	--	Not in use
8	--	Not in use
9	--	Not in use
10	--	Not in use
11	--	Not in use
12	--	Not in use
13	39G	Headlight washer relay 1 + control feed
14	39H	Headlight washer relay 2 + control feed
15	20AH	Opening screen status signal
16	20J	Screen opening motor
17	--	Not in use
18	--	Not in use
19	--	Not in use
20	--	Not in use
GREEN		
Track	Connection	Description
21	26T	Driver's door handle sensor infrared signal
22	26S	Driver's side rear handle sensor infrared signal
23	26Q	Passenger side-opening door handles infrared sensor signal
24	26AU	Keyless vehicle internal aerial 1 signal 2
25	26AT	Keyless vehicle internal aerial 1 signal 1
26	26AY	Keyless vehicle internal aerial 3 signal 2
27	26AB	Keyless vehicle driver's door external aerial signal B
28	26AG	Keyless driver's rear door vehicle external aerial signal A
29	26AN	Keyless vehicle luggage compartment lid external aerial signal 2
30	26AP	Keyless vehicle driver's side-opening doors switch / locking signal
31	26AD	Keyless vehicle right-hand front door external aerial signal 2
32	26AL	Keyless vehicle passenger rear door aerial signal B
33	26AK	Keyless vehicle passenger rear door external aerial signal A
34	26AC	Keyless vehicle passenger front door external aerial signal A
35	26AW	Keyless vehicle internal aerial 2 signal 2
36	26AV	Keyless vehicle internal aerial 1 signal 2
37	26AX	Keyless vehicle internal aerial 3 signal 1
38	26AH	Keyless vehicle driver's rear door aerial signal B
39	26AA	Keyless vehicle driver's door external aerial signal A
40	26AM	Keyless vehicle tailgate external aerial signal A

Fuses and relays

Allocation (according to equipment level)

PP1(4-track connector) **BLACK**

Track	Connection	Description
1	MAM	Left-hand side of instrument panel cross member electrical earth
2	--	Not in use
3	BP77	+ Protected battery > Passenger compartment ECU feed
4	BPS1	Safety + protected battery

Allocation (according to equipment level)

PP2(12-track connector) **BLACK**

Track	Connection	Description
1	26I	+ Column lock feed
2	APCB	Protected + after ignition feed / Column lock fuse contact normally closed
3	36A	Rear screen wiper + control
4	BP25	Rear screen wiper protected battery + feed
5	20BH	Fuel flap / Driver's door locking motor control
6	20BC	Fuel flap / Driver's door opening motors control
7	20BK	Rear doors / Passenger door locking motors control / glove compartments on E84
8	20BD	Rear doors / front passenger door locking motors control / glove compartments on E84
9	BP3	Electric door locking protected battery + feed
10	20X	Front deadlocking motor control
11	20W	Rear deadlocking motor control
12	--	Not in use

Allocation (according to equipment level)

PP3(12-track connector) **GREY**

Track	Connection	Description
1	13E	Courtesy light > Timer - control
2	NAM	Left-hand upper cross member electronic earth
3	BPT	Timer protected battery + feed
4	64C	Left-hand indicator lights control
5	64D	Right-hand indicator lights control
6	9P	Protected rear fog lights + control feed
7	20S	Tailgate opening motor authorised supply
8	20AG	Rear screen opening motor authorised supply
9	BPT2	Timed lighting protected battery + feed
10	13AC	Lighting timer unit + control
11	--	Not in use
12	--	Not in use

Fuses and relays

PROTECTION AND SWITCHING UNIT (1337)

location

This unit is located in the engine interconnection unit (in the engine compartment).



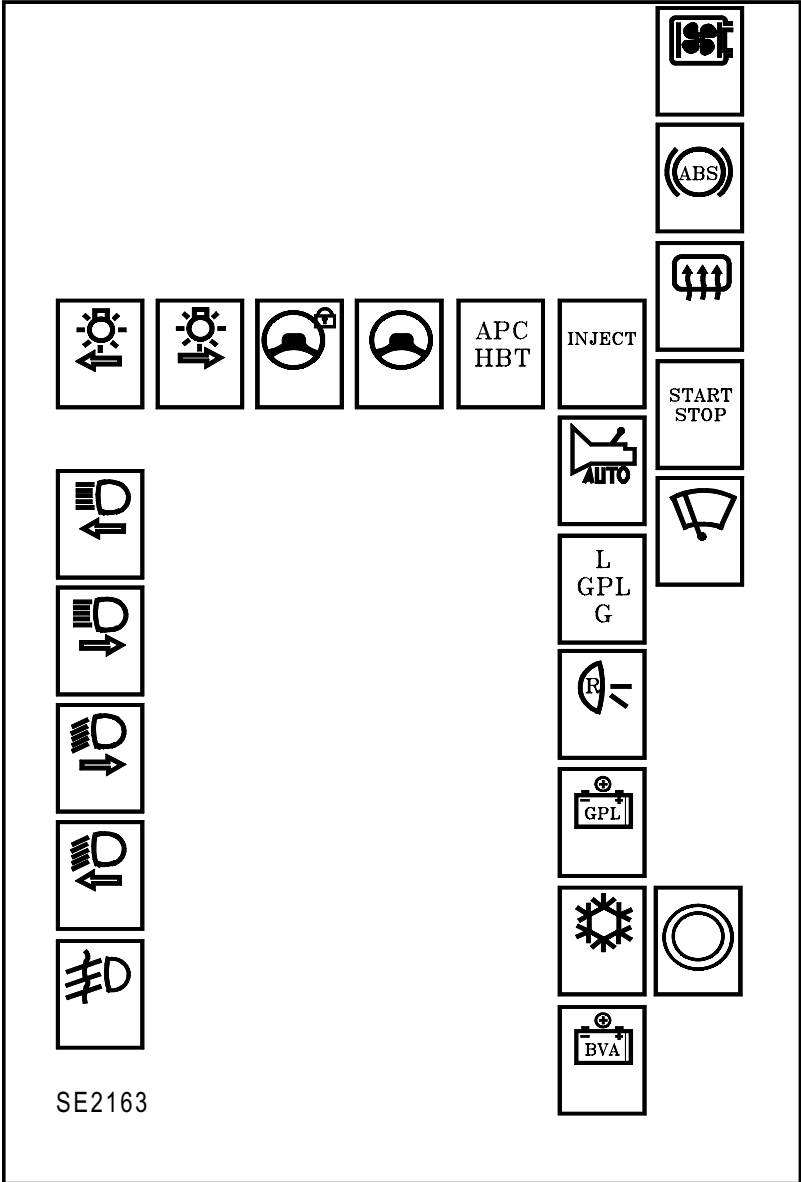





Table of fuses













Fuses and relays

PROTECTION AND SWITCHING UNIT (1337)

Allocation of fuses (depending on equipment level).

No.	Symbol	Amps	Connection	Description
F3	START STOP	25A	(internal)	Fuse: starter motor solenoid (163)
F4		10A	internal	Fuse: air conditioning compressor clutch
F5A		15A	APCB	Fuse: steering column electric lock (1088)
F5C		10A	AP11	Fuse: reversing lights (172)
F5D	INJECT	5A	AP15	Fuse: injection computer + after ignition feed (120) - steering column electric lock (1088)
F5E		5A	AP44	Fuse: airbag + after ignition feed and electric power assisted steering (756-1232)
F5F	APC HBT	7.5A	AP43	Fuse : passenger compartment + after ignition: gear lever display (1129) - shift pattern control (129) - cruise control/speed limiter on/off control (1081) - driving school monitor control (469) - passenger compartment fuse and relay box (260) - auxiliary heater relay 1 (1067) - auxiliary heater relay 2 (1068) - diagnostic socket (225) - hands-free telephone radio microphone (789) - rain and light sensor on E84 (1415) - passenger compartment temperature sensor on E84 (418)
F5H		5A	AP4	Fuse: automatic gear box + after ignition feed (119)
F5G	L GPL G	10A	AP31	Fuse: LPG injection computer + after ignition feed (997)
F6		30A	(internal)	Fuse: heated rear screen (200)
F7A		7.5A	LPD	Fuse: right-hand side light (172-226) - cruise control stop/start control (1081) - ESP stop/start button (1106) - gear selector lever display (1129) - left-hand heated seat control (1514) - right-hand heated seat control (1513) - rigid roof switch (1482) - windscreen simultaneous control (854) - LPG or petrol selector switch (1003)
F7B		7.5A	left-hand headlight	Fuse: left-hand side lights (173-227) - cigarette lighter (101) - hazard warning lights and door locking switch (1004) - left-hand side lights (173-227) - cigarette lighter (101)

Fuses and relays

			connection	(1391) - headlight adjustment rheostat switch (1390) - air conditioning control panel (319) - radio (261) - multifunction display (653) - CCU (1125) - CD changer (1272) - driver's dual front electric window control (1512) - electric door mirror control (134) - rear electric window locking control (135) - driver's dual rear window control (1511) - passenger electric window control (133) - rear right-hand electric window control (130) - rear left-hand electric window control (131)
F8A		10A	RPD	Fuse: right-hand main beam headlights (226)
F8B		10A	RPG	Fuse: left-hand main beam headlights (227)
F8C		10A	CPD	Fuse: right-hand dipped beam headlight (226) - rear height sensor (1372) - front height sensor (1373) - headlight adjustment rheostat switch (1390) - right-hand headlight adjustment motor (538)
F8D		10A	CPG	Fuse: left-hand dipped beam headlight (227) - left-hand headlight adjustment motor (537)
F9		25A	(internal)	Fuse: windscreen wiper motor (212)
F10		20A	8F - 8E	Fuse: front left and right-hand fog lights (176-177)
F11		40A	(internal)	Fuse: engine cooling fan unit (188)
F13		25A	BP14	Fuse: ABS computer (118) or Electronic Stability Program (1094)
F15		20A	BP42	Fuse: automatic gearbox + battery feed (119) or gas solenoid valve relay + battery feed (299)
F16		10A		Not in use

Fuses and relays

PROTECTION AND SWITCHING UNIT (1337)

location

This unit is located in the engine interconnection unit (in the engine compartment).

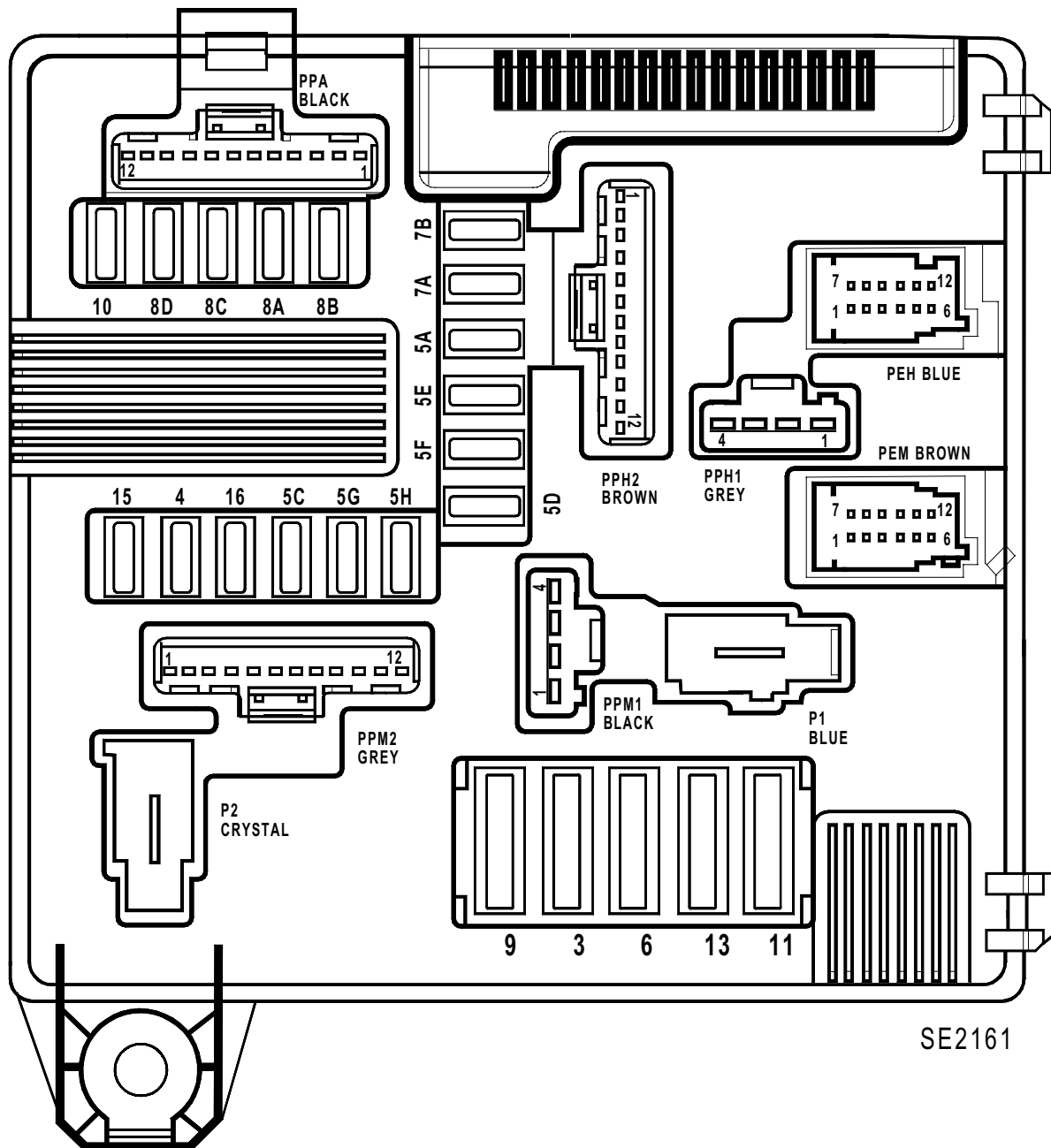

Fuses and relays

Allocation (according to equipment level)

PEH (12-track connector) **BLACK**

Track	Connection	Description
1	AP15	Engine function fuse protected + after ignition feed
2	--	Not in use
3	SP2	+ Protected accessories > Radio (input)
4	32B	Oil - oil level sensor signal 1
5	32A	Oil - oil level sensor signal 2
6	14M	Front wiper park position control > Computer
7	4DN	ABS CAN L SIGNAL
8	CANL	CAN L fault finding signal
9	3SN	Engine CAN L signal 2
10	CANH	CAN H fault finding signal
11	4DM	ABS CAN H signal
12	3SM	Engine CAN H signal

Allocation (according to equipment level)

PPH1(4-track connector) **GREY**

Track	Connection	Description
1	BP14	+ Protected battery > ABS system feed
2	15LP	+ Protected rear screen heating control feed
3	MAS	Left-hand front side member electronic earth
4	3FB	+ Injection > Protection relay (BP31 relayed)

Allocation (according to equipment level)

PPH2 (12-track connector) **BROWN**

Track	Connection	Description
1	14L	Windscreen wiper high speed timer + control feed
2	14K	Windscreen wiper low speed timer + control feed
3	NAM	Left-hand upper cross member electronic earth
4	CPD	+ Right-hand protected dipped beam headlight
5	3N	+ Fuel pump
6	left-hand headlight connection	+ Protected left-hand side light feed
7	LPD	+ Protected right-hand side light
8	APCB	+ Protected after ignition feed / Column lock fuse contact normally closed
9	H66P	Reverse lights + control feed
10	AP44	Electric power assisted steering ECU fuse + protected after ignition feed
11	AP43	Protected fuse + after ignition feed
12	--	Not in use

Fuses and relays

Allocation (according to equipment level)

PPA(12-track connector) **BLACK**

Track	Connection	Description
1	left-hand headlight connection	+ Protected left-hand side light feed
2	LPD	+ Protected right-hand side light
3	RPG	+ Left-hand protected main beam headlight
4	RPD	+ Right-hand protected main beam headlight
5	CPD	+ Right-hand protected dipped beam headlight
6	CPG	+ Left-hand protected dipped beam headlight
7	8F	+ Right-hand front fog light > Resistor
8	8E	+ Left-hand front fog light > Resistor
9	--	Not in use
10	--	Not in use
11	--	Not in use
12	--	Not in use

Allocation (according to equipment level)

PEM (12-track connector) **BLACK**

Track	Connection	Description
1	3AC	Fuel pump relay coil - control
2	3AA	Power latch relay coil - control
3	2K	DF terminal alternator charger signal
4	--	Not in use
5	--	Not in use
6	26Z	Automatic gearbox neutral + signal feed
7	--	Not in use
8	2JD	+ Alternator excitor feed
9	SP2	+ Protected accessories feed > Radio (outlet to diesel heater relay control)
10	32B	Oil - oil level sensor signal 1
11	32A	Oil - oil level sensor signal 2
12	28A	Oil pressure warning light - Control

Allocation (according to equipment level)

PPM1(4-track connector) **BLACK**

Track	Connection	Description
1	3FB1	+ Injection > Protection relay (BP31 relayed)
2	3FB2	+ Injection > Protection relay (BP31 relayed)
3	D	+ Starting
4	49L / 49B	Fan assembly low-speed resistor + control or fan assembly + control feed

Fuses and relays

Allocation (according to equipment level)

PPM2 (12-track connector) **GREY**

Track	Connection	Description
1	BP42	+ Protected battery > automatic gearbox computer or + gas solenoid valve relay battery
2	49Q	Engine fan unit control - relay (on K9K 724 and K9K 732 engines with air conditioning)
3	BP31	injector fuse protected + battery feed > fuel pump (output)
4	--	Not in use
5	38R	Air conditioning clutch + control feed
6	AP11	Reversing lights fuse protected + after ignition feed
7	AP31	LPG ECU fuse protected + after ignition feed
8	3BS	Ignition coil control
9	H66P	Reverse lights + control feed
10	AP4	Automatic gearbox fuse protected + after ignition feed
11	--	Not in use
12	--	Not in use

Allocation (according to equipment level)

P1 (1-track connector) **BLUE**

Track	Connection	Description
1	49R	High-speed fan assembly feed

Allocation (according to equipment level)

P2 (1-track connector) **TRANSPARENT**

Track	Connection	Description
1	BP31	Injector fuse protected + battery feed > fuel pump (input)

Fuses and relays

POWER FEED FUSE BOARD (777)

location

This unit is located in the engine interconnection unit, below the Protection and Switching Unit (1337).

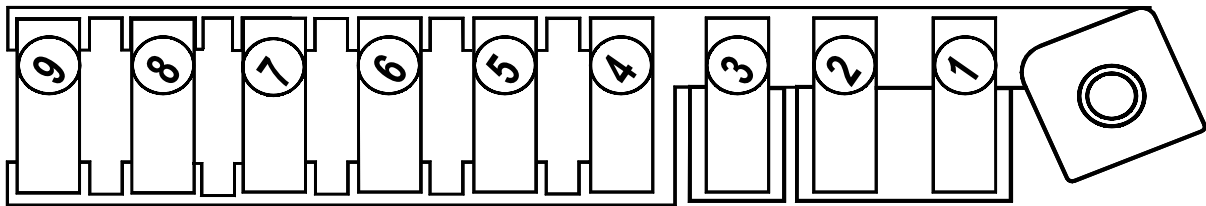

SE2256

Allocation of fuses (depending on equipment level)

No.	Amps	Connection	Description
F1	40A/60A	BP73	Fuse: 460 Watt engine cooling fan (234) (40 Amps on K9K724) or 550 Watts (60 Amps on K9K732)
F2	70A	BP35	Fuse: preheating unit (257)
F3	20A	BP27	Fuse: diesel filter heater relay (450) on F9Q engine
F4	70A	BP12	Fuse: passenger compartment fuse and relay box (260)
F5	50A	BP8	Fuse: ABS computer (118 - 1094)
F6	70A	BP81	Fuse: electric power assisted steering system (1232)
F7	40A	BP9	Fuse: auxiliary heater relay 1 (1067)
F8	60A	BP11	Fuse: passenger compartment fuse and relay box (260)
F9	70A	BP91	Fuse: auxiliary heater relay 2 (1068)

Fuses and relays

PROTECTED POSITIVE BATTERY UNIT (1033)

location

This unit is located on the positive battery terminal.

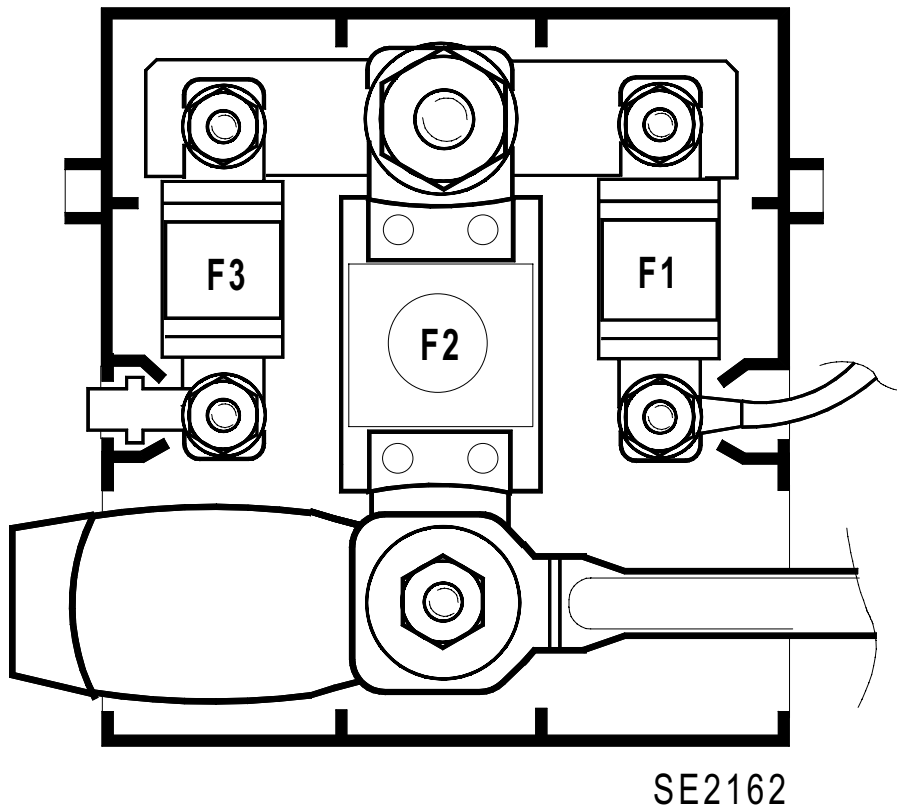

Allocation of fuses (depending on equipment level)

No.	Amps	Conne tion	Description
F1	30A	BPS1	Fuse : passenger compartment fuse and relay box protected + battery feed (260) - UCH (645).
F2	350A 400A	BPDA	Fuse : + protected starter battery (163) - alternator (103) - power feed fuse board (777) - switching and protection unit (1337). Rating: - 350 Amps for petrol engines. - 400 Amps for diesel engines.
F3	30A	BP31	Fuse : + engine function protected battery via protection and switching unit (1337)

Fuses and relays

RELAY BOARD (784)

location

This unit is located in the engine interconnection unit, below the Protection and Switching Unit (1337).

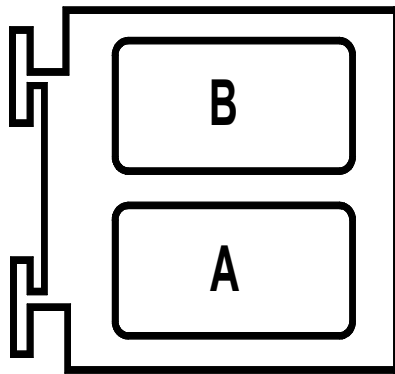

SE2186

Allocation of relays (depending on equipment level)

No.	Amps	Description
A	25A	Relay: headlight washer pump (753)
B	25A	Relay: headlight washer pump 2 (1338)

Fuses and relays

RELAY BOARD (299 - 983)

location

This unit is located in the engine interconnection unit, below the Protection and Switching Unit (1337).

F9Q800 / 808 / 814

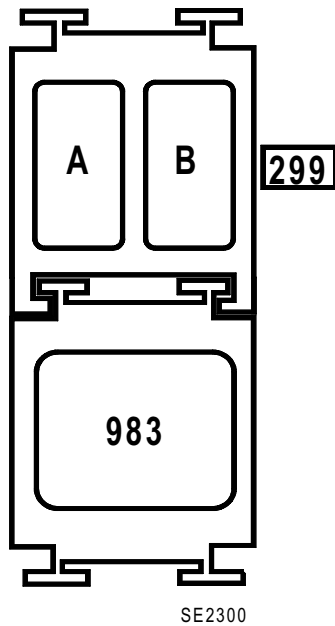

Allocation of relays (depending on equipment level)

Board 299

No.	Amps	Description
A	20A	Relay: diesel heater (450) on all F9Q engines
B	20A	Relay electric coolant pump (573) on F9Q814 engine

Relay unit

No.	Amps	Description
983	50A	Relay: injection control unit feed on the F9Q814 engine

Fuses and relays

FUSE AND RELAY BOARD (777 - 234)

location

This unit is located in the engine interconnection unit, below the Protection and Switching Unit (1337).

K9K724 / 732

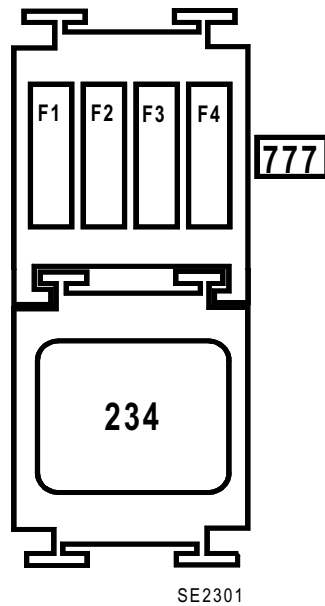

Allocation of relays (depending on equipment level)

Board 777

No.	Amps	Connection	Description
F1	--	--	Not in use
F2	--	--	Not in use
F3	--	--	Not in use
F4	15A	3FB2	Fuse : + feed for main injector relay (238) (air flowmeter feed protection 799)

Relay unit

No.	Amps	Description
234	40A	Relay : 460 Watt engine cooling fan on K9K724 engine with air conditioning
	50A	Relay : 550 Watt engine cooling fan on K9K732 engine with air conditioning

Fuses and relays

LPG RELAY BOARDS (299)

location

This unit is located in the engine interconnection unit, below the Protection and Switching Unit (1337).

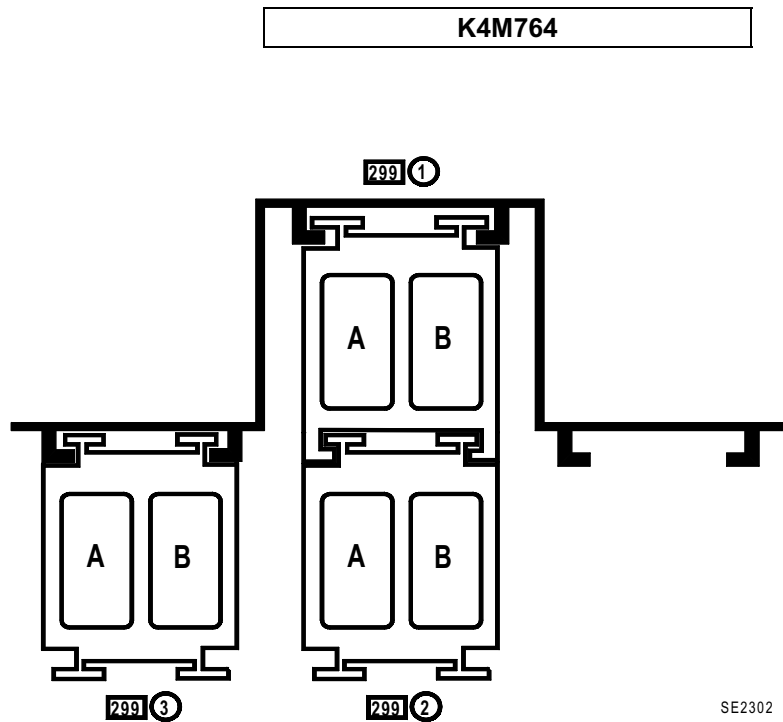

Allocation of relays (depending on equipment level)

Board 299 - 1

No.	Amps	Description
A	20A	Relay : fuel pump (236)
B	20A	Relay : fuel pump cut-off for LPG (1196)

Board 299 - 2

No.	Amps	Description
A	20A	Relay : LPG solenoid valve (1259)
B	20A	Relay : LPG tank (1457)

Board 299 - 3

No.	Amps	Description
A	20A	Relay : gas expansion valve solenoid valve (1682)
B	--	Not in use