

A: (i84) B: (B280) C: (B281) BODY INTEGRATED UNIT

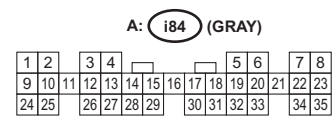

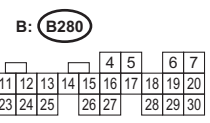

COMBINATION SWITCH (FRONT WIPER & WASHER SWITCH) (B70)

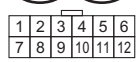
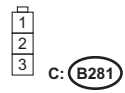
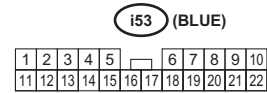
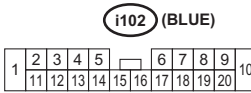
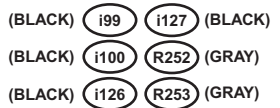
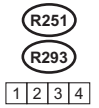
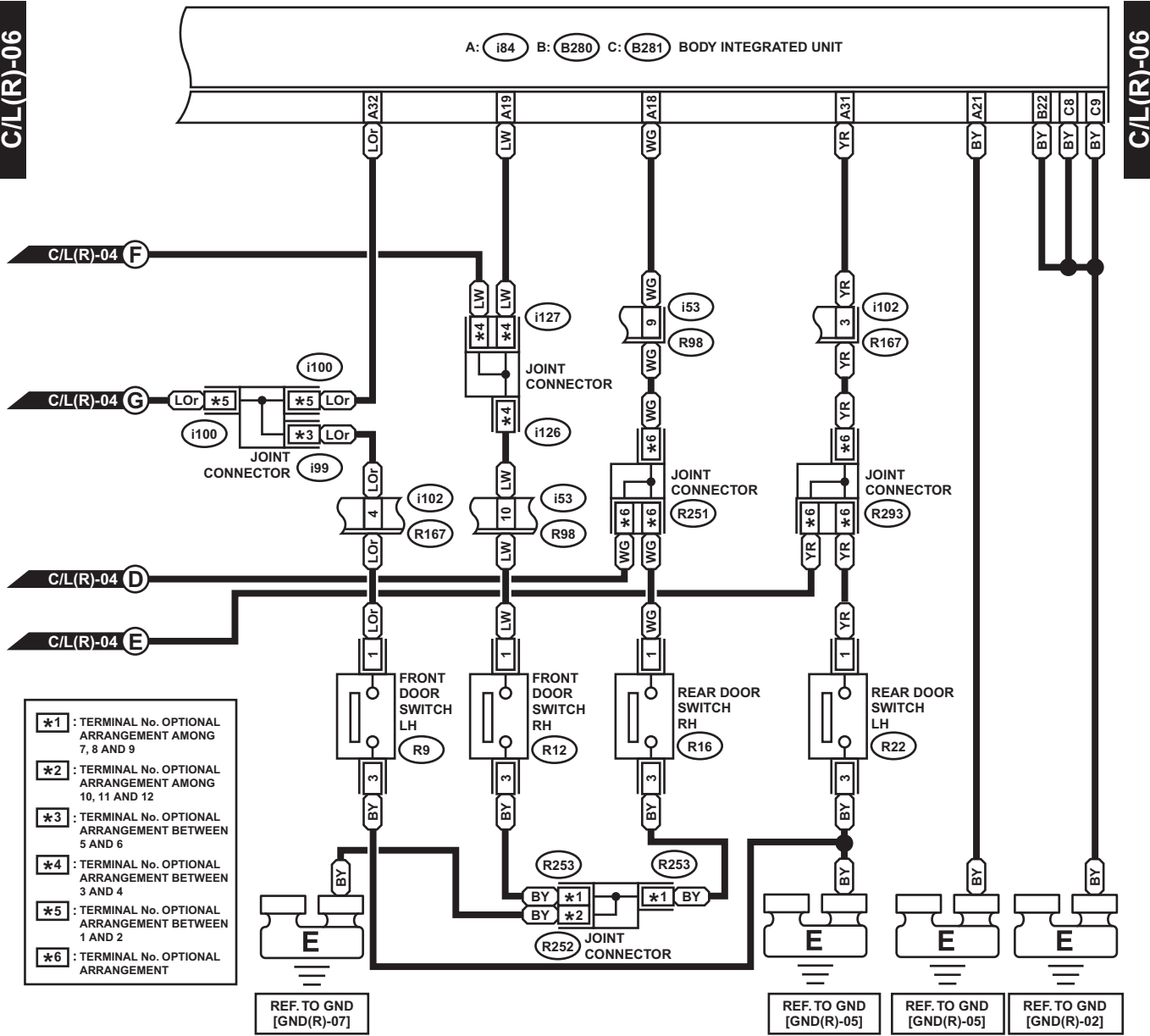
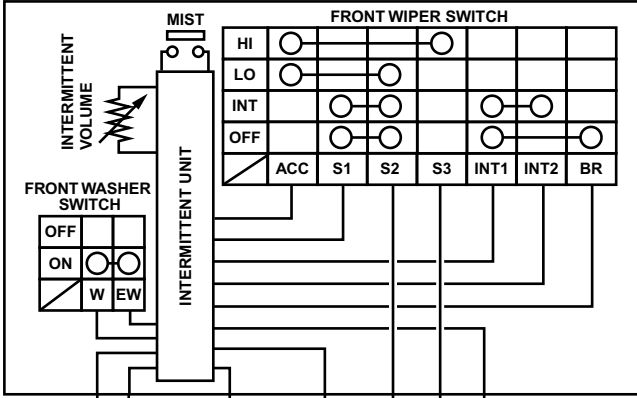
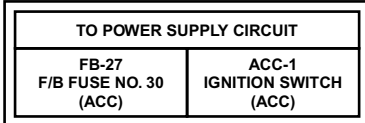
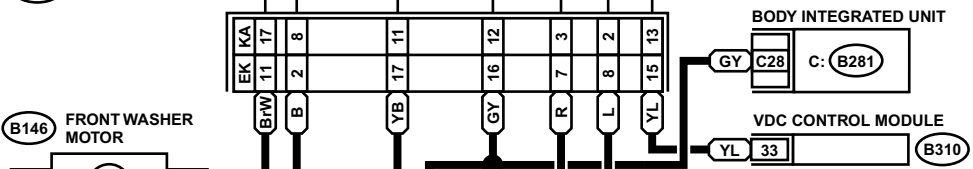
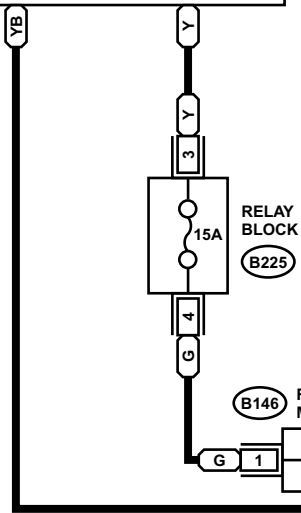

- EK** : EK MODEL
- KA** : KA MODEL
- LH** : LHD MODEL
- RH** : RHD MODEL

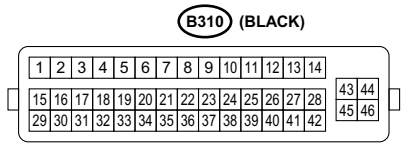
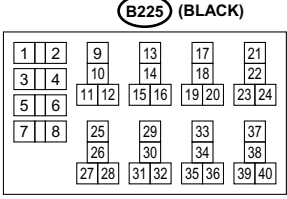
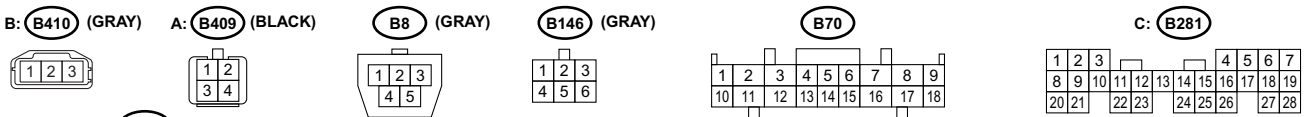
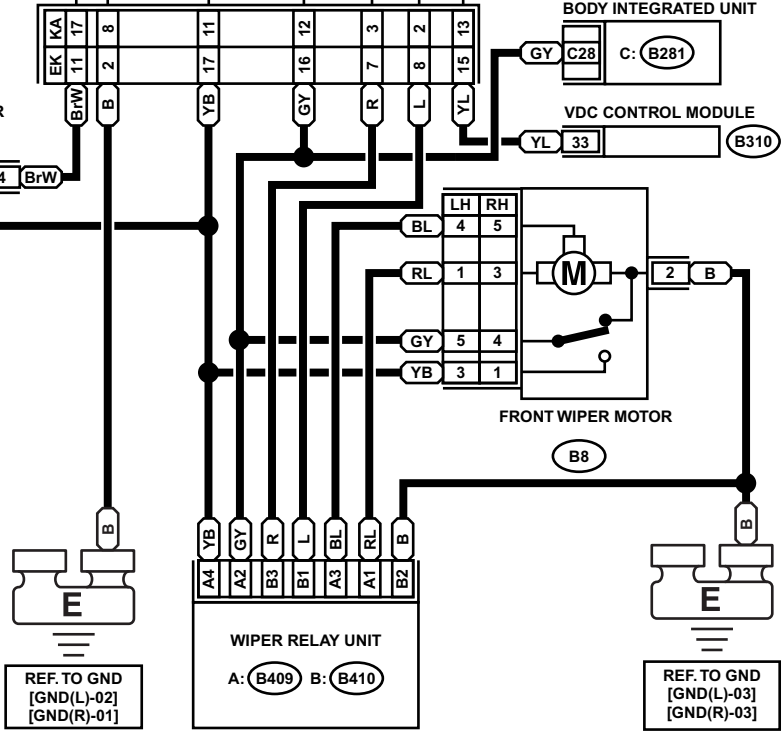

RELAY BLOCK

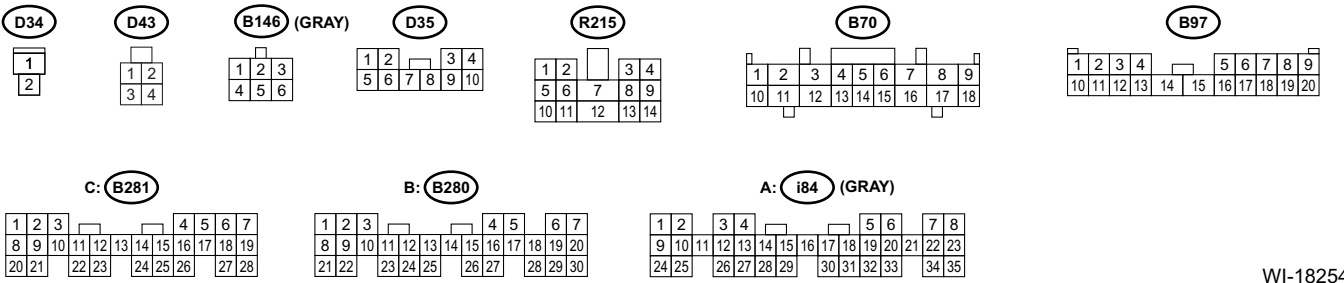
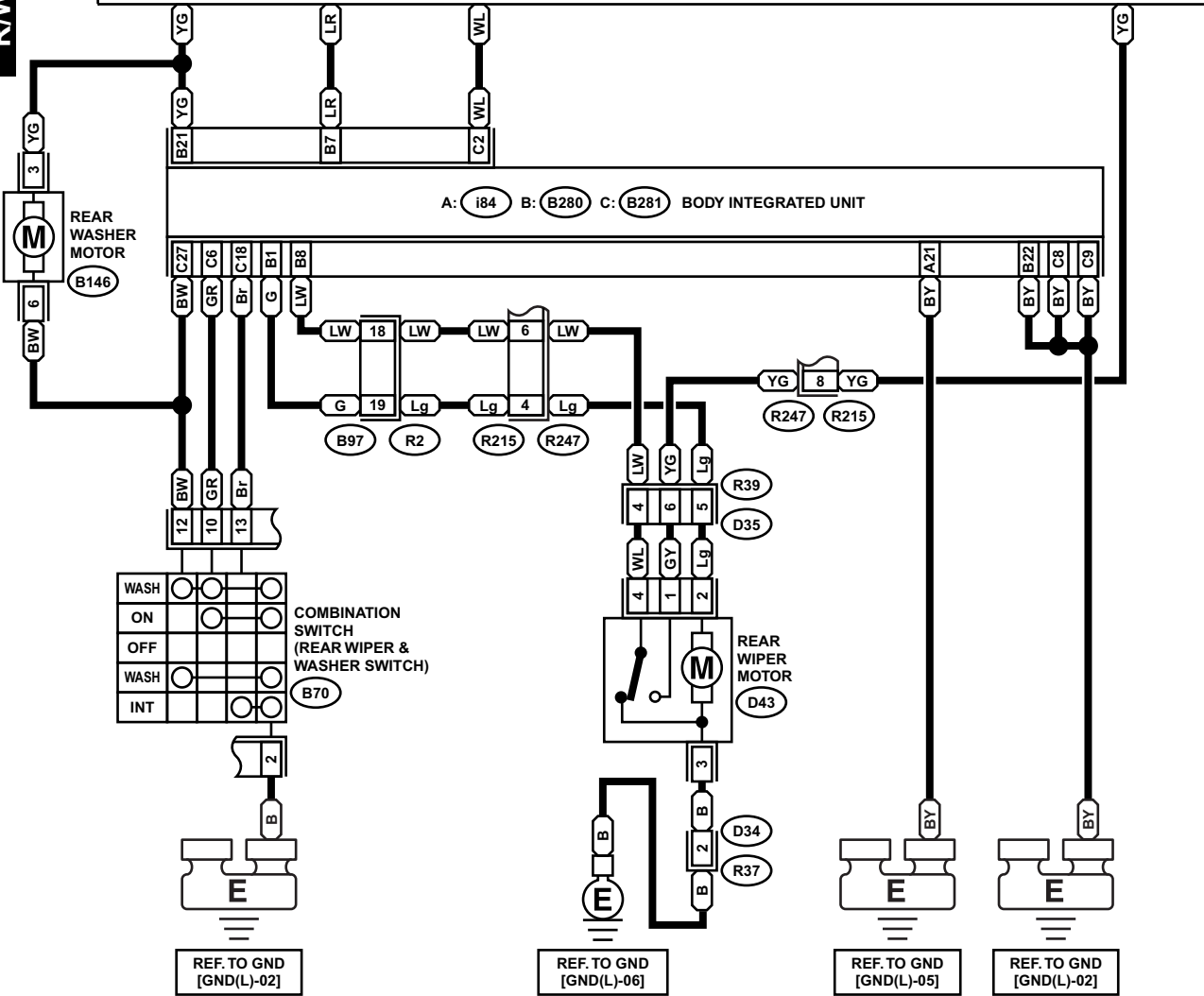
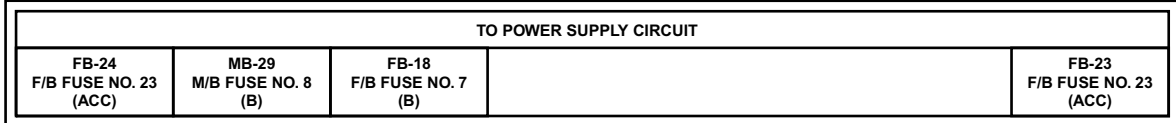

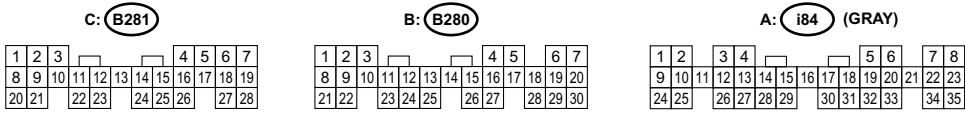
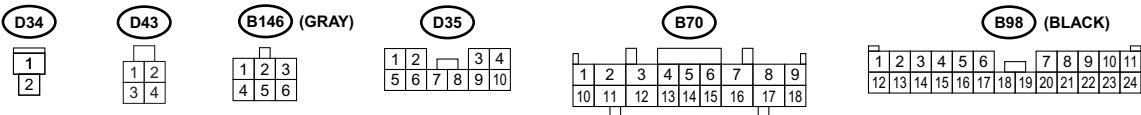
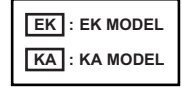
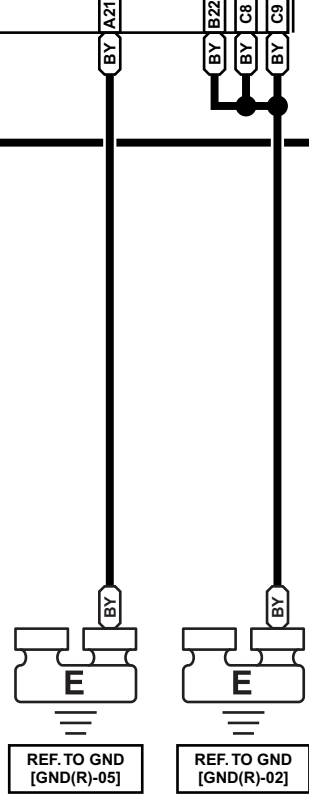
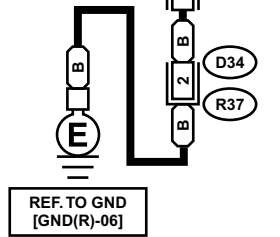
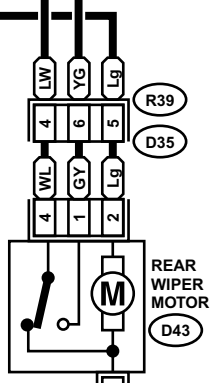
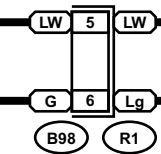
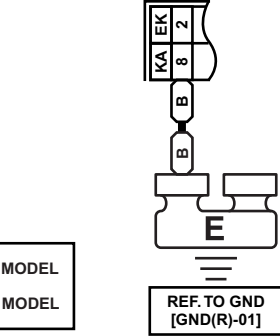
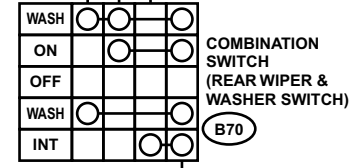
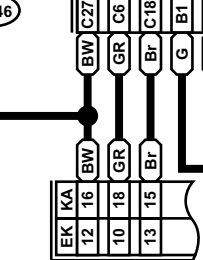
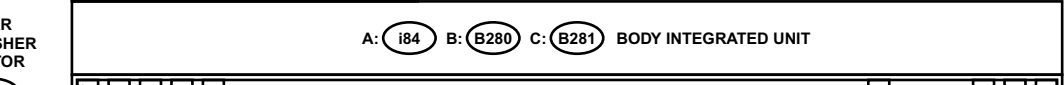
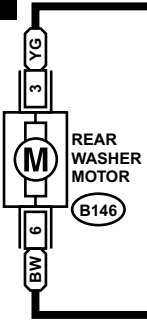
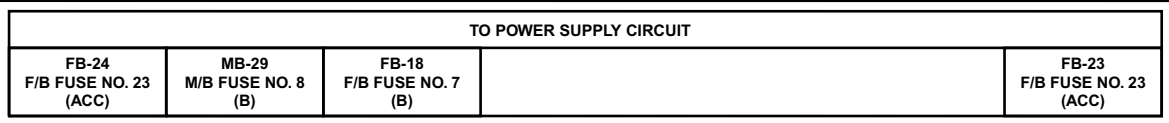

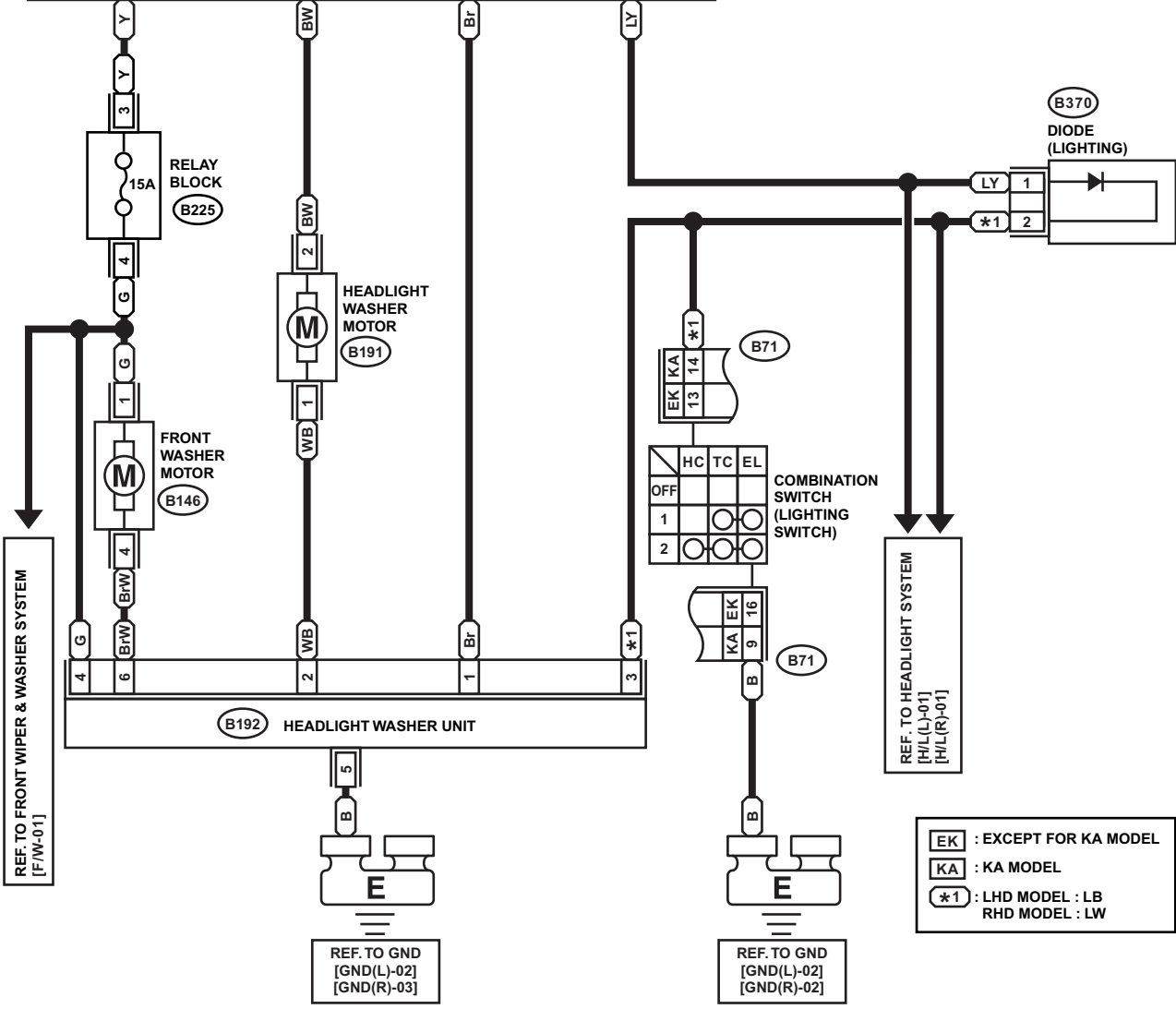
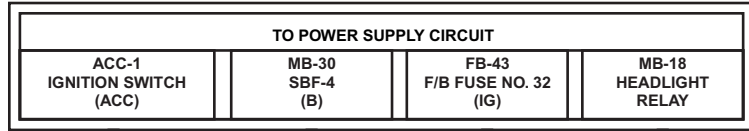

REF. TO FRONT WIPER & WASHER SYSTEM [F/W-01]

REF. TO HEADLIGHT SYSTEM [H/L(L)-01] [H/L(R)-01]

REF. TO GND [GND(L)-02] [GND(R)-03]

REF. TO GND [GND(L)-02] [GND(R)-02]

EK : EXCEPT FOR KA MODEL
KA : KA MODEL
***1** : LHD MODEL : LB
RHD MODEL : LW

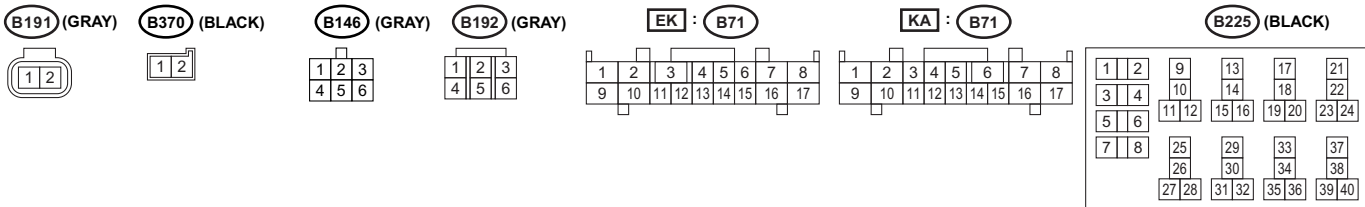

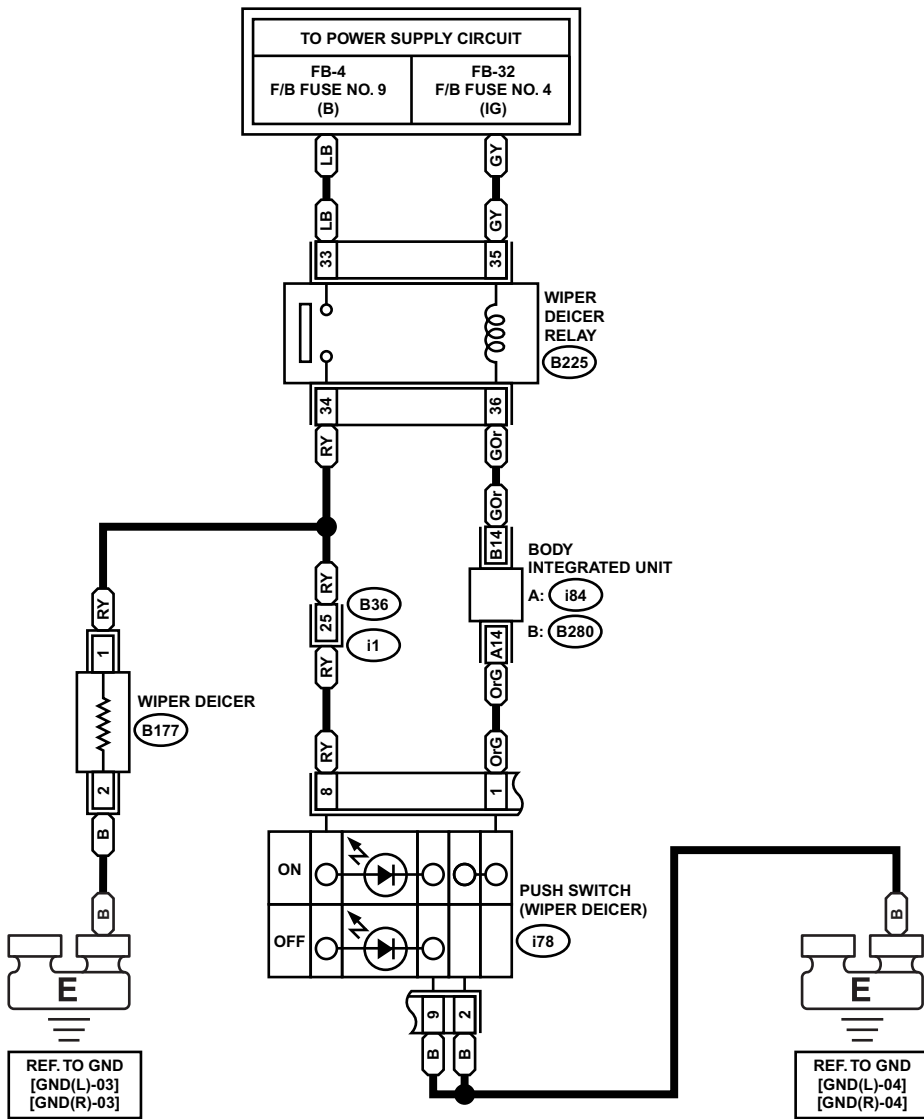

B177



i78 (BLUE)

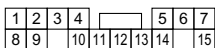

B36 (BLUE)

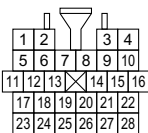

B: B280



A: i84 (GRAY)

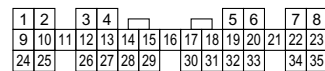

B225 (BLACK)

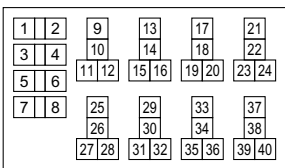

RELAY BLOCK