

Timing Chain Assembly

MECHANICAL

15. Timing Chain Assembly

A: REMOVAL

- 1) Remove the crank pulley. <Ref. to ME(H6DO)-41, REMOVAL, Crank Pulley.>
- 2) Remove the front chain cover. <Ref. to ME(H6DO)-42, REMOVAL, Front Chain Cover.>
- 3) Remove the chain tensioner (RH).

NOTE:

Be careful not to come out the plunger (A).

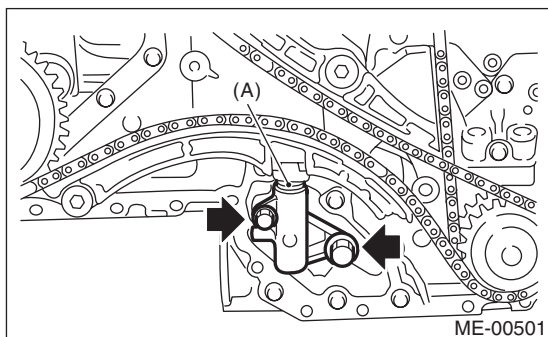

- 4) Remove the chain guide (RH: between cams).

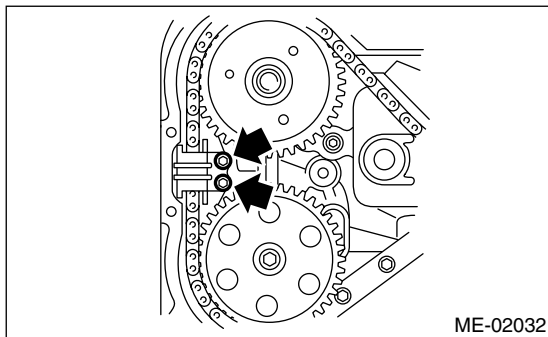

- 5) Remove the chain guide (RH).

- 6) Remove the chain tensioner lever (RH).

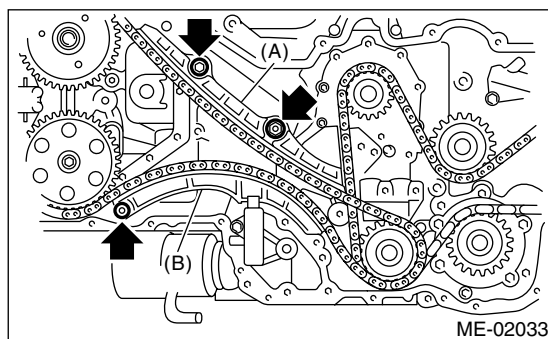

(A) Chain guide (RH)

(B) Chain tensioner lever (RH)

- 7) Remove the timing chain (RH).

- 12) Remove the chain guide (center).

- 8) Remove the chain tensioner (LH).

NOTE:

Be careful not to come out the plunger.

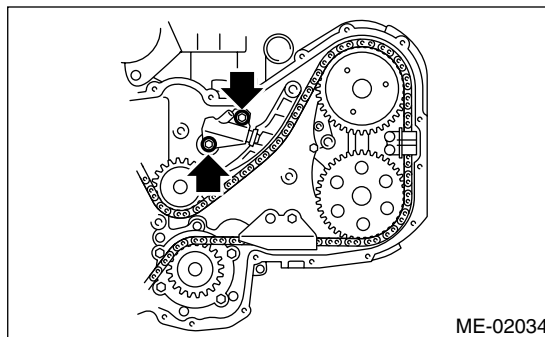

- 9) Remove the chain tensioner lever (LH).

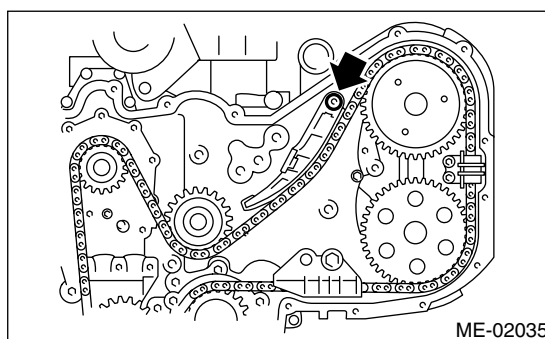

- 10) Remove the chain guide (LH: between cams).

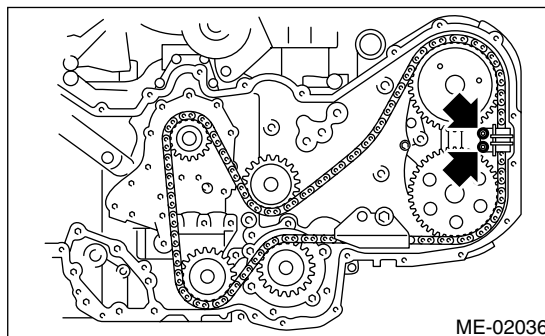

- 11) Remove the chain guide (LH).

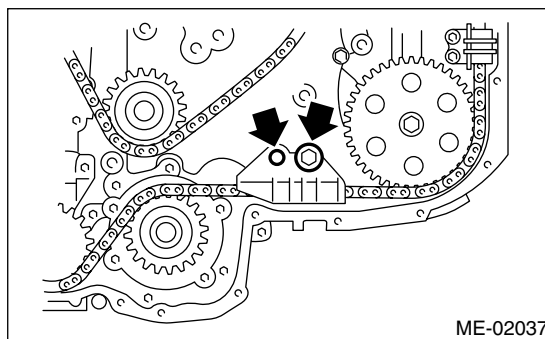

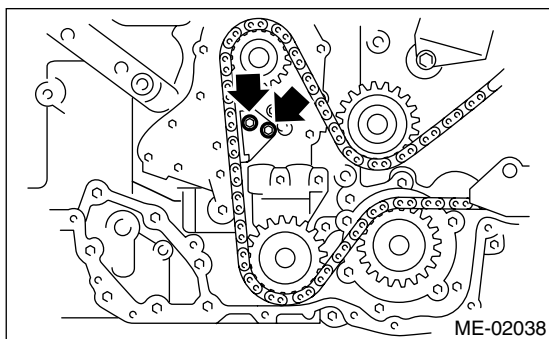

13) Remove the idler sprocket (upper).

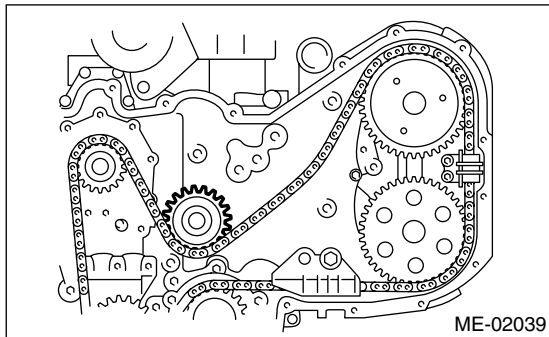

14) Remove the timing chain (LH).

15) Remove the idler sprocket (lower).

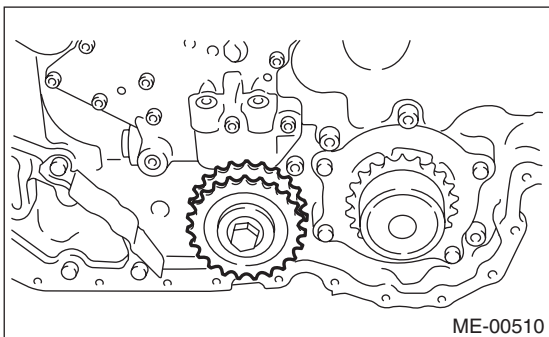

B: INSTALLATION

NOTE:

- Be careful that the foreign matter is not into or onto assembled component during installation.
- Apply engine oil to the chain guide, chain tensioner lever and idler sprocket when installing.

1) Preparation for chain tensioner installation

- (1) Insert the screw, spring pin and tension rod into tensioner body.
- (2) While depressing the tensioner onto rubber mat, twist it to shorten tension rod. Then insert the thin pin into the hole between tension rod and tension body to keep it.

NOTE:

Work on the rubber mat or other anti-skid materials.

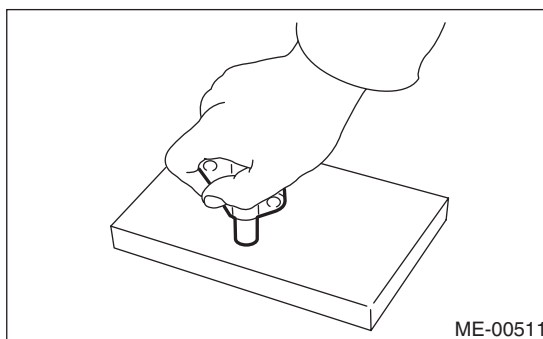

- 2) Using the ST, align the "Top mark" on crank sprocket to 9 o'clock position as shown in the figure
ST 18252AA000 CRANKSHAFT SOCKET

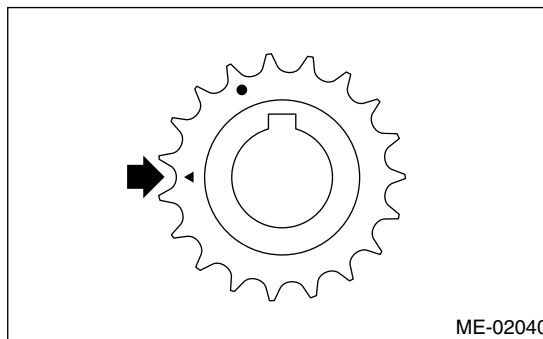

- 3) Align the key groove on exhaust cam sprocket to 12 o'clock position as shown in the figure.

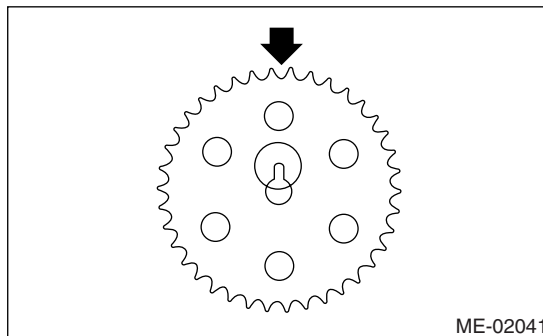

Timing Chain Assembly

MECHANICAL

4) Align the intake cam sprocket as shown in the figure.

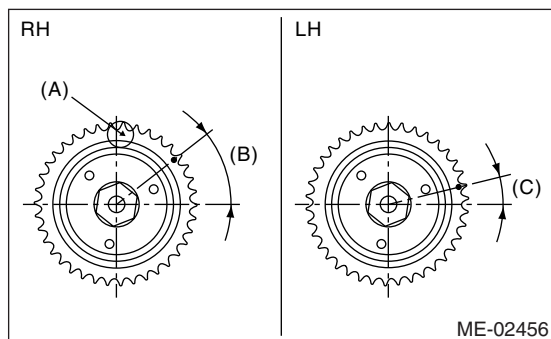

- (A) Top mark
- (B) 40°
- (C) 15°

5) Turn the crank sprocket clockwise, align the "Top mark" to 12 o'clock position. (Piston #1 is in TDC position)

NOTE:

Do not rotate the crank shaft and cam sprocket before completing timing chain installation.

6) Install the idler sprocket (lower).

Tightening torque:

69 N-m (7.0 kgf-m, 50.6 ft-lb)

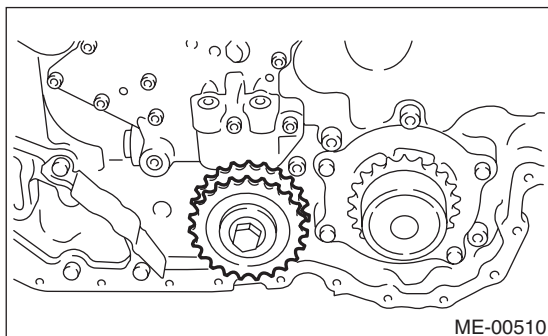

7) Install the timing chain (LH).

(1) Align the timing mark (B) on the crank sprocket with mark (A) on the timing chain (LH).

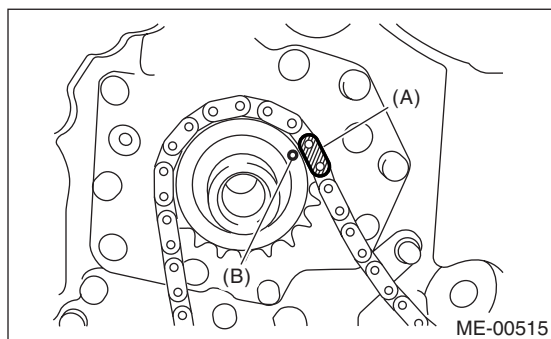

- (A) Gold
- (B) Mark

(2) Install the timing chain (LH) to the idler sprocket (lower), water pump, exhaust cam sprocket (LH) and intake cam sprocket (LH) in this order.

NOTE:

Check that the mark on timing chain (A) and cam sprocket (B) is aligned as same as aligned on crank sprocket.

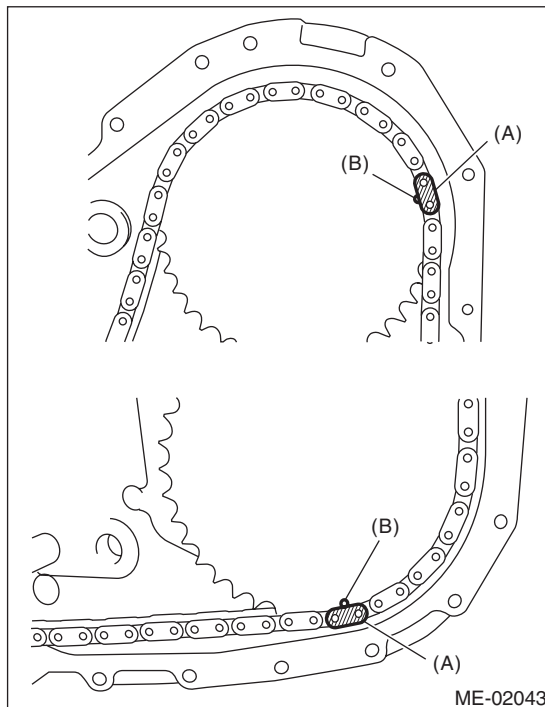

- (A) Blue
- (B) Mark

(3) Install the chain idler (upper).

Tightening torque:

69 N-m (7.0 kgf-m, 50.6 ft-lb)

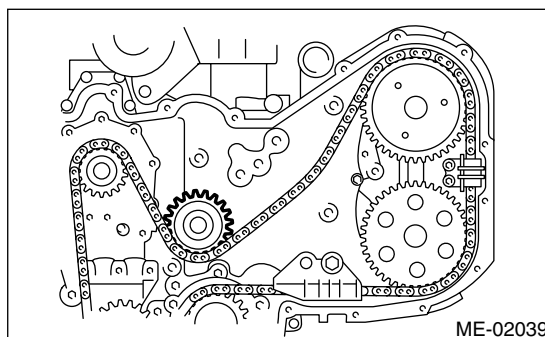

Timing Chain Assembly

MECHANICAL

(4) Install the chain guide (LH: between cams).

Tightening torque:

6.4 N·m (0.65 kgf·m, 4.7 ft·lb)

NOTE:

Use a new installing bolt.

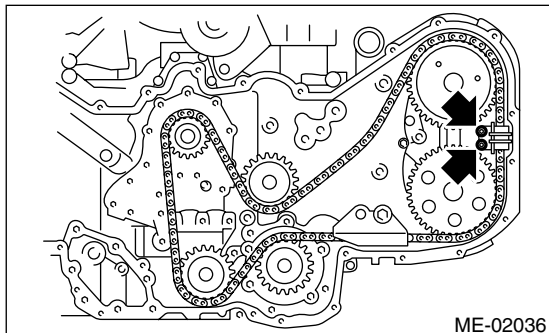

(5) Install the chain guide (LH).

Tightening torque:

16 N·m (1.6 kgf·m, 12 ft·lb)

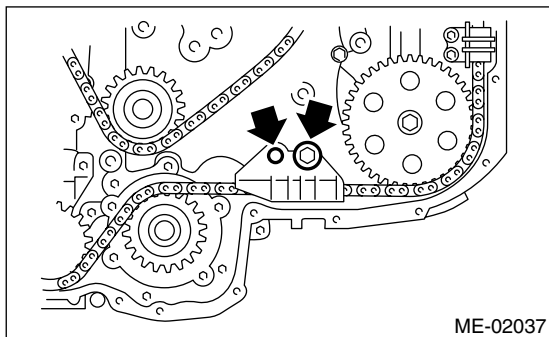

(6) Install the chain tensioner lever (LH).

Tightening torque:

16 N·m (1.6 kgf·m, 12 ft·lb)

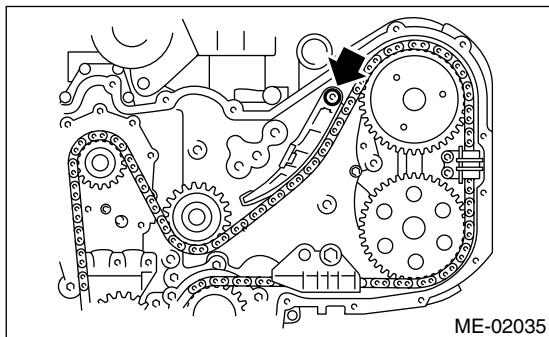

(7) Install the chain tensioner (LH).

Tightening torque:

16 N·m (1.6 kgf·m, 12 ft·lb)

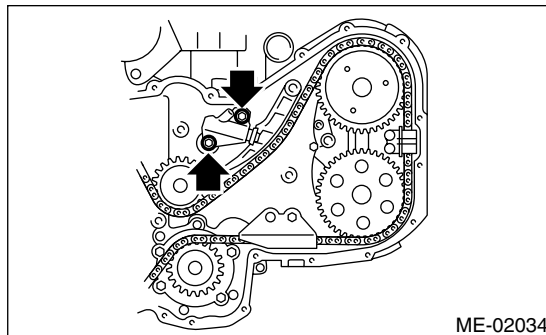

8) Install the timing chain (RH).

(1) Align the marks of timing chain LH and RH on the idler sprocket (lower).

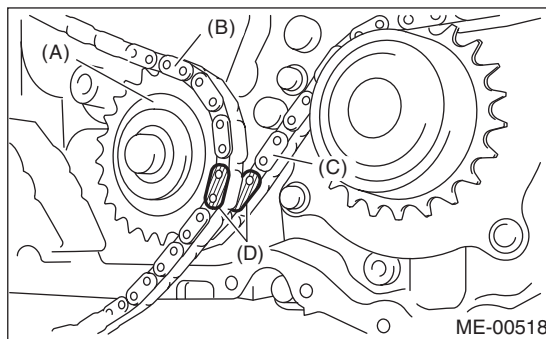

- (A) Idler sprocket (lower)
- (B) Timing chain (RH)
- (C) Timing chain (LH)
- (D) Blue

Timing Chain Assembly

MECHANICAL

- (2) Install the timing chain (RH) to the intake cam sprocket (RH) and exhaust cam sprocket (RH) in this order.

NOTE:

Check that the mark on timing chain (A) and cam sprocket (B) is aligned as same as aligned on crank sprocket.

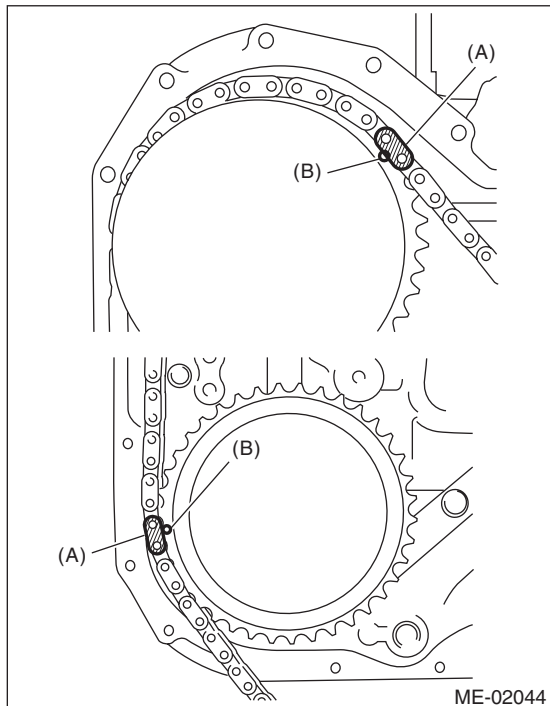

- (A) Gold
(B) Mark

- (3) Install the chain guide (RH).
(4) Install the chain tensioner lever (RH).

Tightening torque:

16 N-m (1.6 kgf-m, 12 ft-lb)

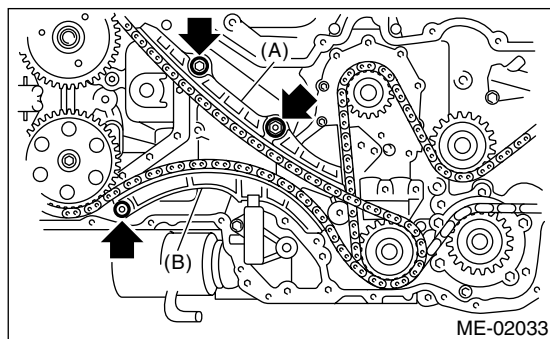

- (A) Chain guide (RH)
(B) Chain tensioner lever (RH)

- (5) Install the chain guide (RH: between cams).

Tightening torque:

6.4 N-m (0.65 kgf-m, 4.7 ft-lb)

NOTE:

Use a new installing bolt.

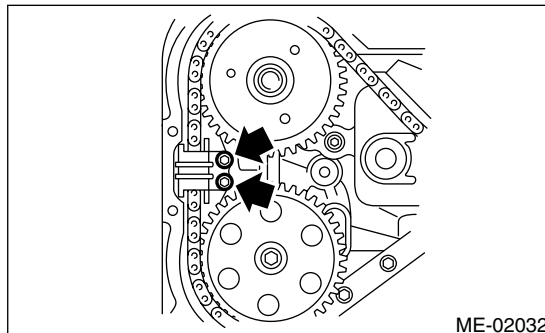

- (6) Install the chain tensioner (RH).

Tightening torque:

16 N-m (1.6 kgf-m, 12 ft-lb)

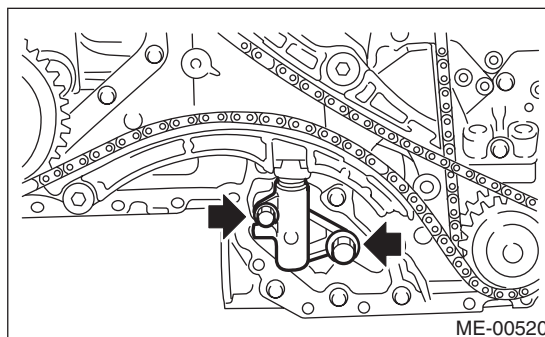

- (7) Adjust the clearance between chain guide (RH) and chain guide (center) within 8.4 — 8.6 mm (0.331 — 0.339 in). Install the chain guide (center).

Tightening torque:

7.8 N-m (0.8 kgf-m, 5.8 ft-lb)

NOTE:

Use a new installing bolt.

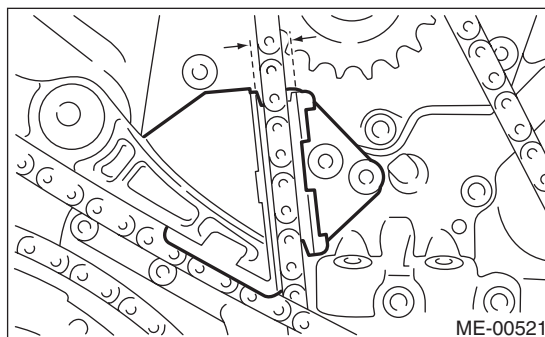

- (8) Check that each mark on the sprocket and timing chain is matched, and then draw out the stopper pin from chain tensioner.