

CONTENTS

Introduction

General Information **1**

Routine Maintenance **2**

Cylinder Head **3**

Clutch **4**

Balancer **5**

Crankshaft/Rods/Pistons **6**

Transmission **7**

Lubrication **8**

Fuel System **9**

Cooling System **10**

Rear Suspension/Final Drive - Twin Sided Swinging Arm **11A**

Rear Suspension/Final Drive - Single Sided Swinging Arm **11B**

Front Suspension/Steering **12**

Brakes **13**

Wheels/Tyres **14**

Frame/Bodywork **15**

Electrical System **16**

Alphabetical Index **17**

INTRODUCTION

This manual is designed primarily for use by trained technicians in a properly equipped workshop. However, it contains enough detail and basic information to make it useful to the owner who desires to perform his own basic maintenance and repair work. The work can only be carried out if the owner has the necessary hand and special service tools to complete the job.

A basic knowledge of mechanics, including the proper use of tools and workshop procedures is necessary in order to carry out maintenance and repair work satisfactorily. Whenever the owner has insufficient experience or doubts his ability to do the work, all adjustments, maintenance, and repair work must be undertaken by an authorised Triumph Dealer.

In order to perform the work efficiently and to avoid costly mistakes, read the text and thoroughly familiarise yourself with procedures before starting work.

All work should be performed with great care and in a clean working area with adequate lighting.

Always use the correct special service tools or equipment specified. Under no circumstances use makeshift tools or equipment since the use of substitutes may adversely affect safe operation.

Where accurate measurements are required, they can only be made using calibrated, precision instruments.

For the duration of the warranty period, all repairs and scheduled maintenance must be performed by an authorised Triumph Dealer.

To maximise the life of your Motorcycle:

- Accurately follow the maintenance requirements of the Periodic Maintenance Chart in the Service Manual.
- Do not allow problems to develop. Investigate unusual noises and changes in the riding characteristics of the motorcycle. Rectify all problems as soon as possible (immediately if safety related).
- Use only genuine Triumph parts as listed in the parts catalogue/parts microfiche.
- Follow the procedures in this manual carefully and completely. Do not take short cuts.
- Keep complete records of all maintenance and repairs with dates and any new parts installed.
- Use only approved lubricants, as specified in the owner's handbook, in the maintenance of the motorcycle.

How to use this manual

To assist in the use of this manual, the section title is given at the top.

Each major section starts with a contents page, listing the information contained in the section.

The individual steps comprising repair operations are to be followed in the sequence in which they appear.

Adjustment and repair operations include reference to service tool numbers and the associated illustration depicts the tool.

Where usage is not obvious the tool is shown in use.

Adjustment and repair operations also include reference to wear limits, relevant data, torque figures, specialist information and useful assembly details.

Warning, Caution and Note

Particularly important information is presented in the following form:



WARNING: This warning symbol identifies special instructions or procedures which, if not correctly followed, could result in personal injury, or loss of life.



CAUTION: This caution symbol identifies special instructions or procedures which, if not strictly observed, could result in damage to or destruction of equipment.

NOTE:

- This note symbol indicates points of particular interest for more efficient and convenient operation.

TAMPERING WITH NOISE CONTROL SYSTEM PROHIBITED**Owners are warned that the law may prohibit:**

- (a) The removal or rendering inoperative by any person other than for purposes of maintenance, repair or replacement, of any device or element of design incorporated into any new vehicle for the purpose of noise control prior to its sale or delivery to the ultimate purchaser or while it is in use; and
- (b) the use of the vehicle after such device or element of design has been removed or rendered inoperative by any person.

REFERENCES**References**

References to the left-hand or right-hand side given in this manual are made when viewing the motorcycle from the rear.

Operations covered in this manual do not always include reference to testing the motorcycle after repair. It is essential that work is inspected and tested after completion and if necessary a road test of the motorcycle is carried out particularly where safety related items are concerned.

Dimensions

The dimensions quoted are to design engineering specification with service limits where applicable.

During the period of running-in from new, certain adjustments may vary from the specification figures given in this manual. These will be reset by the dealer at the 500 mile/800 km service, and thereafter should be maintained at the figures specified in this manual.

REPAIRS AND REPLACEMENTS

Before removal and disassembly, thoroughly clean the motorcycle. Any dirt entering the engine or other parts will work as an abrasive and shorten the life of the motorcycle. Particular attention should be paid when installing a new part, that any dust or metal filings are cleared from the immediate area.

Force

Common sense should dictate how much force is necessary in assembly and disassembly. If a part seems especially difficult to remove or install, stop and examine what may be causing the problem. Never lever a component as this will cause damage both to the component itself and to the surface being levered against.

Whenever tapping to aid removal of an item is necessary, tap lightly using a hide or plastic faced mallet.

Edges

Watch for sharp edges, especially during engine disassembly and assembly. Protect the hands with industrial quality gloves when lifting the engine or turning it over.

When replacement parts are required, it is essential that only genuine Triumph parts are used.

Safety features and corrosion prevention treatments embodied in the motorcycle may be impaired if other than genuine Triumph parts are fitted. In certain territories, legislation prohibits the fitting of parts not to the manufacturer's specification.

Tightening procedure

Generally, when installing a part with several bolts, nuts or screws, they should all be started in their holes and tightened to a snug fit, evenly and in a cross pattern. This is to avoid distortion of the part and/or causing gas or oil leakage. Conversely, bolts, nuts, or screws, should all be loosened (in sequence if specified) by about a quarter of turn and then removed.

Where there is a tightening sequence specified in this Service Manual, the bolts, nuts, or screws must be tightened in the order and by the method indicated.

Torque wrench setting figures given in this Manual must be observed. The torque tools used must be of accurate calibration.

Locking devices, where specified, must be fitted. If the efficiency of a locking device is impaired during removal it must be renewed. This applies particularly to micro-encapsulated fixings which must always be replaced if disturbed. Where necessary, the text in this manual will indicate where such a fixing is used.

GENERAL INFORMATION

CONTENTS

	Page
IGNITION SYSTEM SAFETY PRECAUTIONS	1.3
DANGEROUS SUBSTANCES	1.3
Fluoroelastomers	1.3
ENGINE OILS	1.3
Health Protection Precautions	1.3
ENVIRONMENTAL PROTECTION PRECAUTIONS	1.4
BRAKES	1.4
SAFETY INSTRUCTIONS	1.5
Jacking and lifting	1.5
Precautions against damage	1.5
Engine Coolant	1.5
Cleaning components	1.5
Lubrication	1.6
Joints and joint faces	1.6
Gaskets, O-rings	1.6
Liquid gasket, non-permanent locking agent	1.6
Screw threads	1.6
Locking devices	1.7
Fitting a split pin	1.7
Circlips, retaining rings	1.7
Self locking nuts	1.7
Encapsulated bolt	1.7
Oil and grease seals	1.7
Press	1.7
Ball bearing	1.7
FUEL HANDLING PRECAUTIONS	1.8
General	1.8
Petrol - Gasoline	1.8
Fuel tank removal	1.8
Chassis repairs	1.8
PRECAUTIONS	1.9
Battery disconnecting	1.9
Disciplines	1.10
Electrical wires	1.10
Inspection	1.10
Replacement Parts	1.10
Service data	1.10

CONTENTS

	Page
SERVICE TOOLS	1.11
SPECIFICATION	1.14
TORQUE WRENCH SETTINGS	1.21
Cylinder Head Area	1.21
Clutch	1.21
Balancer, Crankshaft and Crankcase	1.21
Engine Covers	1.21
Transmission	1.22
Lubrication System	1.22
Final Drive - single sided swinging arm versions	1.22
Final Drive - twin sided swinging arm versions	1.22
Cooling System	1.23
Fuel System, Exhaust System and Airbox	1.23
Rear Suspension - single sided swinging arm models	1.23
Rear Suspension - twin sided swinging arm models	1.24
Front Suspension	1.24
Wheels	1.24
Front Brakes	1.24
Rear Brakes	1.24
Footrests, Control Plates and Engine Mountings	1.25
Electrical	1.25
Bodywork	1.25

IGNITION SYSTEM SAFETY PRECAUTIONS

 **WARNING:** The ignition system produces extremely high voltages. Do not touch any part of the ignition system or any cables while the engine is running.

An electric shock caused by contact with the ignition system may lead to illness, injury or death.

 **WARNING:** Wearers of surgically implanted heart pacemaker devices should not be in close proximity to ignition circuits and or diagnostic equipment.

The ignition system and any diagnostic equipment may interrupt the normal operation of such devices causing illness or death.

DANGEROUS SUBSTANCES

 **WARNING:** Many liquids and other substances used in motor vehicles are poisonous and should under no circumstances be consumed and should, as far as possible, be kept from contact with the skin. These substances among others include acid, anti-freeze, asbestos, brake fluid, fuel, lubricants, and various adhesives. Always pay close attention to the instructions printed on labels and obey the instructions contained within. These instructions are included for your safety and well being. **NEVER DISREGARD THESE INSTRUCTIONS!**

Fluoroelastomers

 **WARNING:** Fluoroelastomer material is used in the manufacture of various seals in Triumph motorcycles.

In fire conditions involving temperatures greater than 315°C this material will decompose and can then be potentially hazardous. Highly toxic and corrosive decomposition products, including hydrogen fluoride, carbonyl fluoride, fluorinated olefins and carbon monoxide can be generated and will be present in fumes from fires.

In the presence of any water or humidity hydrogen fluoride may dissolve to form extremely corrosive liquid hydrofluoric acid.

If such conditions exist, do not touch the material and avoid all skin contact. Skin contact with liquid or decomposition residues can cause painful and penetrating burns leading to permanent, irreversible skin and tissue damage.

ENGINE OILS

 **WARNING:** The oil may be hot to the touch. Contact with hot oil may cause the skin to be scalded or burned.

 **WARNING:** Prolonged or repeated contact with engine oil can lead to skin dryness, irritation and dermatitis. In addition used engine oil contains potentially harmful contaminants which can cause cancer. Wear suitable clothing and avoid skin contact.

Health Protection Precautions

- Avoid prolonged and repeated contact with oils, particularly used engine oils.
- Wear protective clothing, including impervious gloves where practicable.
- Do not put oily rags in pockets.
- Overalls must be cleaned regularly. Discard heavily soiled clothing and oil impregnated footwear.
- First aid treatment should be obtained immediately for open cuts and wounds. Always be aware of who your nearest first aider is and where the medical facilities are kept.
- Use barrier creams, applying before each work period to protect the skin from the effects of oil and grease and, to aid removal of the same after completing work.
- Wash with soap and water to ensure all oil is removed (skin cleansers and nail brushes will help). Preparations containing lanolin replace the natural skin oils which have been removed.
- Do not use petrol, kerosene, diesel fuel, gas oil, thinners or solvents for cleaning skin.
- If skin disorders develop, obtain medical advice without delay.
- Where practicable, de-grease components prior to handling.

 **WARNING:** Any risk of eye injury must be avoided. Always wear eye protection when using a hammer, air line, cleaning agent or where there is ANY risk of flying debris or chemical splashing

ENVIRONMENTAL PROTECTION PRECAUTIONS



CAUTION: Do not pour oil on the ground, down sewers or drains, or into water courses. To prevent pollution of water courses etc., dispose of used oil sensibly. If in doubt contact your local authority.

Burning of used engine oil in small space heaters or boilers can be recommended only for units of approved design. If in doubt check with the appropriate local authority and/or manufacturer of the approved appliance.

Dispose of used oil and used filters through authorised waste disposal contractors, to licensed waste disposal sites, or to the waste oil reclamation trade. If in doubt, contact the Local Authority for advice on disposal facilities.

BRAKES



WARNING: Brake fluid is hygroscopic which means it will absorb moisture from the air. Any absorbed moisture will greatly reduce the boiling point of the brake fluid causing a reduction in braking efficiency.

Replace brake fluid in line with the routine maintenance schedule. A dangerous riding condition could result if this important maintenance item is neglected!

Do not spill brake fluid onto any area of the bodywork as this will damage any painted or plastic surface.

Always use new brake fluid from a sealed container and never use fluid from an unsealed container or from one which has been previously opened.

Do not mix different brands of fluid. Check for fluid leakage around brake fittings, seals and joints.

Check regularly for brake hose damage.

FAILURE TO OBSERVE ANY OF THE ABOVE WARNINGS MAY REDUCE BRAKING EFFICIENCY LEADING TO AN ACCIDENT.



WARNING: If there has been an appreciable drop in the level of the fluid in either brake fluid reservoir, consult your authorised Triumph Dealer for advice before riding.

If the brake lever or pedal feels soft when it is applied, or if the lever/pedal travel becomes excessive, there may be air in the brake lines or the brake may be defective.

It is dangerous to operate the motorcycle under such conditions and remedial action must be taken by your authorised Triumph Dealer before riding the motorcycle.

Failure to take remedial action may reduce braking efficiency leading to an accident.



WARNING: Use only D.O.T. 4 specification brake fluid as listed in the general information section of this manual. The use of brake fluids other than those D.O.T. 4 fluids listed in the general information section may reduce the efficiency of the braking system leading to an accident.

Failure to change the brake fluid at the interval specified in the routine maintenance schedule may reduce braking efficiency resulting in an accident.



WARNING: Never use mineral based grease in any part of the braking system or in any area where contact with the braking system is possible. Mineral based grease will damage the hydraulic seals in the calipers and master cylinders.

Damage caused by contact with mineral based grease may reduce braking efficiency resulting in an accident.

SAFETY INSTRUCTIONS

Jacking and lifting

 Always ensure that any lifting apparatus has adequate load and safety capacity for the weight to be lifted. Ensure the motorcycle is well supported to prevent any possibility of the machine falling prior to, and during lifting or jacking.

Never rely on a single means of support when working with the motorcycle. Use additional safety supports.

Do not leave tools, lifting equipment, spilt oil, etc. in a place where they could become a hazard to health. Always work in a clean, tidy area and put all tools away when the work is finished.

Precautions against damage

Avoid spilling brake fluid or battery acid on any part of the bodywork. Wash spillages off with water immediately.

Disconnect the battery earth lead before starting work, see **ELECTRICAL PRECAUTIONS**.

Always use the recommended service tool where specified.

Protect exposed bearing and sealing surfaces, and screw threads from damage.

Engine Coolant

 **WARNING:** Coolant mixture which is blended with anti-freeze and corrosion inhibitors contains toxic chemicals which are harmful to the human body. Never swallow anti-freeze, corrosion inhibitors or any of the motorcycle coolant.

 **WARNING:** Do not remove the radiator cap when the engine is hot. When the engine is hot, the coolant inside the radiator is hot and also under pressure. Contact with the pressurised coolant will cause scalds and skin damage.

 **CAUTION:** The coolant anti-freeze contains a corrosion inhibitor which helps prevent damage to the metal surfaces inside the cooling system. Without this inhibitor, the coolant would 'attack' the metals and the resulting corrosion would cause blockages in the cooling system leading to engine overheating and damage. Always use the correct anti-freeze as specified in the Owner's Handbook. Never use a methanol based anti-freeze as this does not contain the required corrosion inhibition properties.

 **CAUTION:** Distilled water must be used with the anti-freeze (see specification for anti-freeze) in the cooling system.

If hard water is used in the system, it causes scale accumulation in the water passages, and considerably reduces the efficiency of the cooling system. Reduced cooling system efficiency may lead to the engine overheating and suffering severe damage.

Cleaning components

A high flash-point solvent is recommended to reduce fire hazard.

Always follow container directions regarding the use of any solvent.

Always use the recommended cleaning agent or equivalent.

Do not use degreasing equipment for components containing items which could be damaged by the use of this process. Whenever possible, clean components and the area surrounding them before removal. Always observe scrupulous cleanliness when cleaning dismantled components.

Lubrication

Engine wear is generally at its maximum while the engine is warming up and before all the rubbing surfaces have an adequate lubricative film. During assembly, oil or grease (whichever is more suitable) should be applied to any rubbing surface which has lost its lubricative film. Old grease and dirty oil should be cleaned off. This is because used lubricants will have lost some lubricative qualities and may contain abrasive foreign particles.

Use recommended lubricants. Some oils and greases in particular should be used only in certain applications and may be harmful if used in an application for which they are not intended. This manual makes reference to molybdenum disulphide grease in the assembly of certain engine and chassis parts. Always check manufacturer recommendations before using such special lubricants.

Joints and joint faces

Assemble joints dry unless otherwise specified in this Manual.

If gaskets and/or jointing compound is recommended for use; remove all traces of old jointing material prior to reassembly. Do not use a tool which will damage the joint faces and smooth out any scratches or burrs on the joint faces using an oil stone. Do not allow dirt or jointing material to enter any tapped holes.

Gaskets, O-rings

Do not re-use a gasket or O-ring once it has been in service. The mating surfaces around the gasket should be free of foreign matter and perfectly smooth to avoid oil or compression leaks.

Liquid gasket, non-permanent locking agent

Follow manufacturer's directions for cleaning and preparing surfaces where these compounds will be used. Apply sparingly as excessive amounts of sealer may block engine oil passages and cause serious damage.

Prior to reassembly, blow through any pipes, channels or crevices with compressed air.



WARNING: To prevent injury, always use eye, face and ear protection when using compressed air. Always wear protective gloves if the compressed air is to be directed in proximity to the skin.

Screw threads

Metric threads to ISO standard are used.

Damaged nuts, bolts and screws must always be discarded.

Castellated nuts must not be slackened back to accept a split-pin, except in those recommended cases when this forms part of an adjustment.

Do not allow oil or grease to enter blind threaded holes. The hydraulic action on screwing in the bolt or stud could split the housing.

Always tighten a nut or bolt to the recommended torque figure. Damaged or corroded threads can affect the torque reading.

Unless specified, threaded fixings must always be fitted dry (no lubrication).



WARNING: Never lubricate a thread unless instructed to do so.
When a thread of a fixing is lubricated, the thread friction is reduced. When the fixing is tightened, reduced friction will cause overtightening and possible fixing failure.
A fixing which fails in service could cause component detachment leading to loss of control and an accident.

Locking devices

Always release locking tabs and fit new locking washers, do not re-use locking tabs.

Fitting a split pin

Always fit new split-pins of the correct size for the hole in the bolt or stud. Do not slacken back castle nuts when fitting split pin.

Always fit new roll pins of an interference fit in the hole.

Circlips, retaining rings

Replace any circlips and retaining rings that are removed. Removal weakens and deforms circlips causing looseness in the circlip groove. When installing circlips and retaining rings, take care to compress or expand them only enough to install them.

Always use the correct replacement circlip as recommended in the Triumph parts catalogue.

Self locking nuts

Self-locking nuts can be re-used, providing resistance can be felt when the locking portion passes over the thread of the bolt or stud.

DO NOT re-use self-locking nuts in critical locations, e.g. suspension components. Always use the correct replacement self-locking nut.

Encapsulated bolt

An encapsulated bolt can be identified by a coloured section of thread which is treated with a locking agent.

Unless a specified repair procedure states otherwise, encapsulated bolts cannot be reused and **MUST** be replaced if disturbed or removed.



WARNING: Failure to replace an encapsulated bolt could lead to a dangerous riding condition. Always replace encapsulated bolts.

Oil and grease seals

Replace any oil or grease seals that are removed. Removal will cause damage to an oil seal which, if re-used, would cause an oil leak.

Ensure the surface on which the new seal is to run is free of burrs or scratches. Renew the component if the original sealing surface cannot be completely restored.

Protect the seal from any surface which could cause damage over which it has to pass when being fitted. Use a protective sleeve or tape to cover the relevant surface and avoid touching the sealing lip.

Lubricate the sealing lips with a recommended lubricant. This will help to prevent damage in initial use. On dual lipped seals, smear the area between the lips with grease.

When pressing in a seal which has manufacturer's marks, press in with the marks facing out.

Seals must be pressed into place using a suitable driver. Use of improper tools will damage the seal.

Press

A part installed using a press or driver, such as a wheel bearing, should first be coated with oil on its outer or inner circumference so that it will locate smoothly.

Ball bearing

When installing a ball bearing, the bearing race which is an interference fit should be pushed by a suitable driver. This prevents severe stress or damage to the load carrying components. Press a ball bearing until it touches the shoulder in the bore or on the shaft.

Press or drift seals to the depth of its housing, with the sealing lip facing the lubricant to be retained if the housing is shouldered, or flush with the face of the housing where no shoulder is provided.

FUEL HANDLING PRECAUTIONS

General

The following information provides basic precautions which must be observed if petrol (gasoline) is to be handled safely. It also outlines other areas of risk which must not be ignored. This information is issued for basic guidance only and, if in doubt, appropriate enquiries should be made of your local Fire Officer.

Petrol - Gasoline

When petrol (gasoline) evaporates it produces 150 times its own volume in vapour which when diluted with air becomes a readily ignitable mixture. The vapour is heavier than air and will always fall to the lowest level. It can readily be distributed throughout a workshop by air currents, consequently, even a small spillage of petrol (gasoline) is potentially very dangerous.



WARNING: Petrol (gasoline) is highly flammable and can be explosive under certain conditions. When opening the fuel tank cap always observe all the following items;

Turn the motorcycle ignition switch OFF.

Do not smoke.

Always have a fire extinguisher containing FOAM, CO², HALON or POWDER close at hand when handling or draining fuel or fuel systems. Fire extinguishers must also be present in areas where fuel is stored.

Always disconnect the vehicle battery, negative (black) lead first, before carrying out dismantling or draining work on a fuel system.

Whenever petrol (gasoline) is being handled, drained or stored or when fuel systems are being dismantled, make sure the area is well ventilated. All potential forms of ignition must be extinguished or removed (this includes any appliance with a pilot light). Any lead-lamps must be flame-proof and kept clear of any fuel spillage.

Warning notices must be posted at a safe distance from the site of the work to warn others that petrol is being openly handled. The notice must instruct the reader of the precautions which must be taken.

Failure to observe any of the above warnings may lead to a fire hazard which could result in personal injury.



WARNING: No one should be permitted to repair components associated with petrol/gasoline without first having specialist training on the fire hazards which may be created by incorrect installation and repair of items associated with petrol/gasoline.

Repairs carried out by untrained personnel could bring about a safety hazard leading to a risk of personal injury.



WARNING: Draining or extraction of petrol/gasoline from a vehicle fuel tank must be carried out in a well ventilated area.

The receptacle used to contain the petrol/ gasoline must be more than adequate for the full amount of fuel to be extracted or drained. The receptacle should be clearly marked with its contents, and placed in a safe storage area which meets the requirements of local authority regulations.

When petrol/gasoline has been extracted or drained from a fuel tank, the precautions governing naked lights and ignition sources should be maintained.

Failure to observe any of the above warnings could bring about a safety hazard leading to a risk of personal injury.

Fuel tank removal

Fuel tanks should have a 'PETROL (GASOLINE) VAPOUR' warning label attached to them as soon as they are removed from the vehicle. In all cases, they must be stored in a secured, marked area.

Chassis repairs



WARNING: If the motorcycle is involved in an accident or collision it must be taken to an authorised Triumph dealer for repair or inspection. Any accident can cause damage to the motorcycle which, if not correctly repaired, may cause a second accident which may result in injury or death.

The frame must not be modified as any modification to the frame such as welding or drilling may weaken the frame resulting in an accident.

ELECTRICAL PRECAUTIONS

The following guidelines are intended to ensure the safety of the operator whilst preventing damage to the electrical and electronic components fitted to the motorcycle. Where necessary, specific precautions are detailed in the relevant sections of this manual which should be referred to prior to commencing repair operations.

Equipment – Prior to commencing any test procedure on the motorcycle ensure that the relevant test equipment is working correctly and any harness or connectors are in good condition, in particular mains leads and plugs.



WARNING: The ignition system produces extremely high voltages. Do not touch any part of the ignition system or any cables while the engine is running.

An electric shock caused by contact with the ignition system may lead to illness, injury or death.



WARNING: Wearers of surgically implanted heart pacemaker devices should not be in close proximity to ignition circuits and or diagnostic equipment.

The ignition system and any diagnostic equipment may interrupt the normal operation of such devices causing illness or death.



WARNING: The battery contains harmful materials. Always keep children away from the battery whether or not it is fitted in the motorcycle.

Do not jump start the battery, touch the battery cables together or reverse the polarity of the cables as any of these actions may cause a spark which would ignite battery gasses causing a risk of personal injury.

High Voltage Circuits – Whenever disconnecting live H.T. circuits always use insulated pliers. Exercise caution when measuring the voltage on the coil terminals while the engine is running, high voltage spikes can occur on these terminals.

Connectors and Harness – The engine of a motorcycle is a particularly hostile environment for electrical components and connectors. Always ensure these items are dry and oil free before disconnecting and connecting test equipment. Never force connectors apart either by using tools or by pulling on the wiring itself. Always ensure locking mechanisms are disengaged before removal and note the orientation to enable correct reconnection. Ensure that any protective covers and substances are replaced if disturbed.

Having confirmed a component to be faulty, switch off the ignition and disconnect the battery negative (black) lead first. Remove the component and support the disconnected harness. When replacing the component keep oily hands away from electrical connection areas and push connectors home until any locking mechanism becomes fully engaged.

Battery disconnecting

Before disconnecting the battery, switch off all electrical equipment.



WARNING: To prevent the risk of a battery exploding and to prevent damage to electrical components **ALWAYS** disconnect the battery negative (black) lead first. When reconnecting the battery, always connect the positive (red) lead first, then the negative (black) lead. Always disconnect the battery when working on any part of the electrical system.

Failure to observe the above warnings may lead to electrical damage and a fire hazard which could cause personal injury.

Always ensure that battery leads are routed correctly and are not close to any potential chafing points.

Disciplines

Switch off the ignition prior to making any connection or disconnection in the system. An electrical surge can be caused by disconnecting 'live' connections which can damage electronic components.

Ensure hands and work surfaces are clean and free of grease, swarf, etc. as grease collects dirt which can cause tracking or high-resistance contacts.

Prior to commencing any test, and periodically during any test, touch a good earth to discharge body static. This is because some electronic components are vulnerable to static electricity.

Electrical wires

All the electrical wires are either single-colour or two-colour and, with only a few exceptions, must be connected to wires of the same colour. On any of the two-colour wires there is a greater amount of one colour and a lesser amount of a second colour. A two-colour wire is identified by first the primary colour and then the secondary colour. For example, a yellow wire with thin red stripes is referred to as a 'yellow/red' wire; it would be a 'red/yellow' wire if the colours were reversed to make red the main colour.

Inspection

Disassembled parts should be visually inspected and replaced with new ones if there are any signs of the following:

Abrasions, cracks, hardening, warping, bending, dents, scratches, colour changes, deterioration, seizure or damage of any nature.

Replacement Parts

 **WARNING: Only Triumph approved parts should be used to service, repair or convert Triumph motorcycles. To ensure that Triumph approved parts are used, always order parts, accessories and conversions from an authorised Triumph dealer. The fitting of non-approved parts, accessories or conversions may adversely affect the handling, stability or other aspects of the motorcycle operation which may result in an accident causing serious injury or death.**

 **WARNING: Always have Triumph approved parts, accessories and conversions fitted by an authorised Triumph dealer. The fitment of parts, accessories and conversions by a dealer who is not an authorised Triumph dealer may affect the handling, stability or other aspects of the motorcycle operation which may result in an accident causing serious injury or death.**

 **WARNING: Always have Triumph approved parts, accessories and conversions fitted by a trained technician. To ensure that a trained technician is used, have an authorised Triumph dealer fit the parts. The fitment of parts, accessories and conversions by personnel other than a trained technician at an authorised Triumph dealer may affect the handling, stability or other aspects of the motorcycle operation which may result in an accident causing serious injury or death.**

Service data

The service data listed in this manual gives dimensions and specifications for brand new, original parts. Where it is permissible to allow a part to exceed these figures, then the service limit is given.

The terms of the motorcycle warranty will be invalidated by the fitting of other than genuine Triumph parts.

All genuine Triumph parts have the full backing of the motorcycle warranty. Triumph dealers are obliged to supply only genuine Triumph recommended parts.

Specification

Triumph are constantly seeking to improve the specification, design and production of their motorcycles and alterations take place accordingly.

While every effort has been made to ensure the accuracy of this Manual, it should not be regarded as an infallible guide to current specifications of any particular motorcycle.

Authorised Triumph Dealers are not agents of Triumph and have no authority to bind the manufacturer by any expressed or implied undertaking or representation.

Service tools and garage equipment

Special service tools have been developed to facilitate removal, dismantling and assembly of certain mechanical components in a practical manner without causing damage. Some operations in this Service Manual cannot be carried out without the aid of the relevant service tools. Where this is the case, the tools required will be described during the procedure.

Special service tools:-

3880075-T0301 - Wheel Bearing Fitment

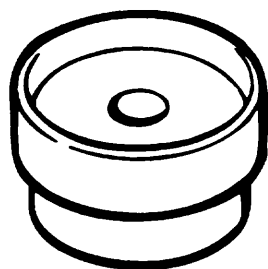

T3880105 - Angular Torque Gauge

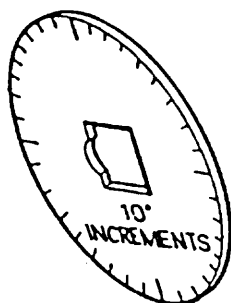

3880070-T0301 - Wheel Bearing Fitment

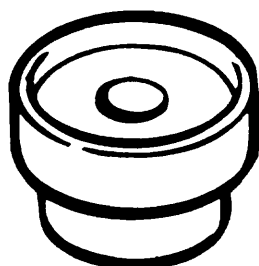

T3880371 - Holder, Oil Pump Drive Gear

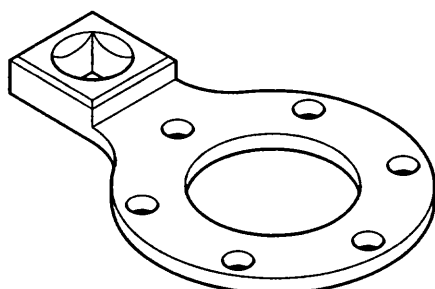

T3880250 - Engine Management Diagnostics

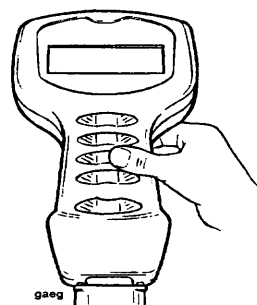

T3880300 - Wrench, Yoke Upper Nut

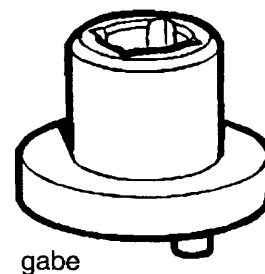

gag

3880090-T0301 - Fork Piston Holder

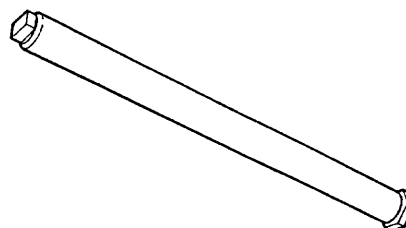

T3880017 - Holder, Sprag Clutch

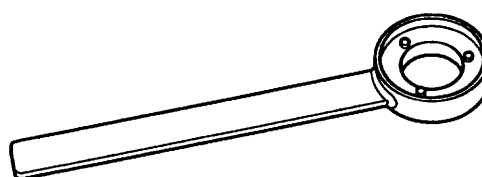

mm

T3880048 - Fuel Pressure Gauge

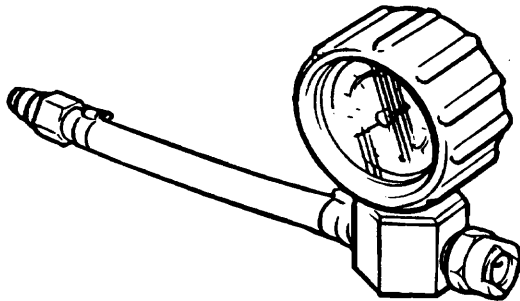

T3880311 - Oil Filter Wrench

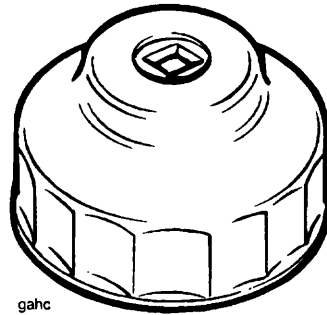

gahc

3880160-T0301 - Fork Filler/Evacuator

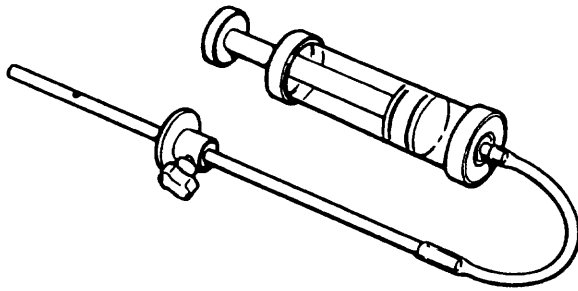

T3880315 - Extractor - Cylinder Liners

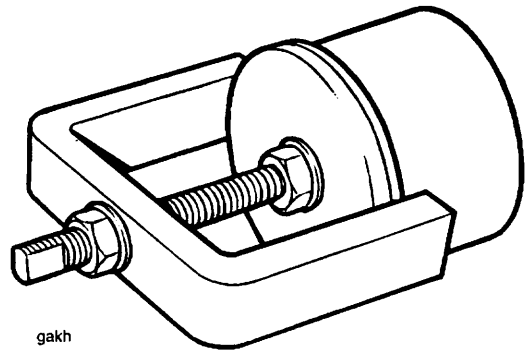

gakh

T3880305 - Clutch Anti-rotation Tool

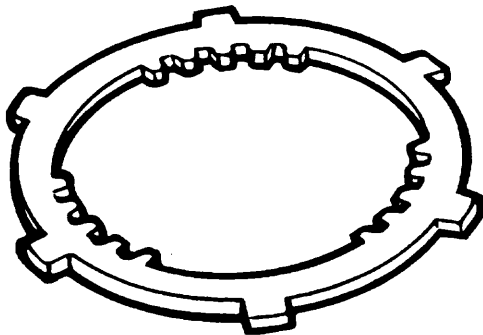

T3880365 - Puller, Alternator Rotor

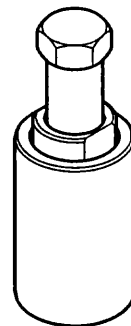

T3880375 - Alternator rotor holder

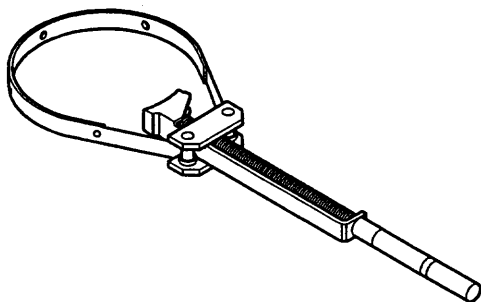

T3880016 - Holder, Balancer Gear

