

Contents

LIVING WITH YOUR VW POLO

Introduction	Page 0.4
Safety first!	Page 0.5

Roadside repairs

Introduction	Page 0.6
If your car won't start	Page 0.6
Jump starting	Page 0.7
Wheel changing	Page 0.8
Identifying leaks	Page 0.9
Towing	Page 0.9

Weekly checks

Introduction	Page 0.10
Underbonnet check points	Page 0.10
Engine oil level	Page 0.11
Coolant level	Page 0.11
Brake fluid level	Page 0.12
Screen washer fluid level	Page 0.12
Wiper blades	Page 0.13
Battery	Page 0.13
Tyre condition and pressure	Page 0.14
Bulbs and fuses	Page 0.15

Lubricants, fluids and tyre pressures	Page 0.16
---------------------------------------	-----------

MAINTENANCE

Routine maintenance and servicing	Page 1.1
Maintenance schedule	Page 1.3
Maintenance procedures	Page 1.5

Contents

REPAIRS & OVERHAUL

Engine and associated systems

Petrol engine in-car repair procedures	Page 2A.1
Engine removal and overhaul procedures	Page 2B.1
Cooling, heating and ventilation systems	Page 3.1
Fuel/exhaust systems - single-point petrol injection models	Page 4A.1
Fuel/exhaust systems - multi-point petrol injection models	Page 4B.1
Exhaust and emission control systems	Page 4C.1
Engine electrical - starting and charging systems	Page 5A.1
Engine electrical - Ignition system	Page 5B.1

Transmission

Clutch	Page 6.1
Manual transmission	Page 7.1
Driveshafts	Page 8.1

Brakes and suspension

Braking system	Page 9.1
Suspension and steering	Page 10.1

Body equipment

Bodywork and fittings	Page 11.1
Body electrical systems	Page 12.1

Wiring diagrams	Page 12.12
-----------------	------------

REFERENCE

Dimensions and weights	Page REF.1
Conversion factors	Page REF.2
Buying spare parts and vehicle identification	Page REF.3
General repair procedures	Page REF.4
Jacking and vehicle support	Page REF.5
MOT test checks	Page REF.5
Fault finding	Page REF.12
Glossary of technical terms	Page REF.19

Index	Page REF.24
-------	-------------

0.4 Introduction

The updated VW Polo range was introduced in November of 1990, with a choice of 1.05 litre (1043 cc) or 1.3 litre (1272 cc) petrol engines, with either single-point or multi-point fuel injection. During Spring 1991, the G40 model was launched, equipped with a supercharged version of the 1.3 litre engine. Three body shells are available - a three-door hatchback, a two-door saloon and a three-door Coupe.

All engines are derived from the well-proven units which have appeared in previous versions of the VW Polo. The engine is of four-cylinder overhead camshaft design, mounted transversely, with the transmission mounted on the left-hand side. All models have a four or five-speed manual transmission.

All models have fully-independent front suspension and employ coil-over-damper struts, transverse lower arms and an anti-roll bar. The rear suspension is semi-independent, utilising coil-over-damper struts and incorporating trailing arms located by a torsion beam axle. A rear anti-roll bar is fitted to certain models.

The WV Polo Team

Haynes manuals are produced by dedicated and enthusiastic people working in close co-operation. The team responsible for the creation of this book included:

Authors	Andy Legg Spencer Drayton
Sub-editor	Carole Turk
Editor & Page Make-up	Bob Jex Pete Shoemark
Workshop manager	Paul Buckland
Photo Scans	John Martin Paul Tanswell Steve Tanswell
Cover illustration & Line Art	Roger Healing
Wiring diagrams	Matthew Marke

We hope the book will help you to get the maximum enjoyment from your car. By carrying out routine maintenance as described you will ensure your car's reliability and preserve its resale value.

A wide range of standard and optional equipment is available within the Polo range to suit most tastes, including a sliding sunroof, tinted glass, alloy wheels and remote adjustable door mirrors.

Provided that regular servicing is carried out in accordance with the manufacturer's recommendations, the VW Polo should prove reliable and very economical. The engine compartment is well-designed, and most of the items requiring frequent attention are easily accessible.

Your Polo manual

The aim of this manual is to help you get the best value from your vehicle. It can do so in several ways. It can help you decide what work must be done (even if you choose to get it done by a garage). It will also provide information on routine maintenance and servicing, and give a logical course of action and diagnosis when random faults occur. However, it is hoped that you will use the manual by tackling the work yourself. On simpler jobs it may even be quicker than booking the car into a garage and going there twice, to leave and collect it. Perhaps most important, a lot of money can be saved by avoiding the costs a garage must charge to cover its labour and overheads.

The manual has drawings and descriptions to show the function of the various components so that their layout can be understood. Tasks are described and photographed in a clear step-by-step sequence.

This manual is not a direct reproduction of the vehicle manufacturer's data, and its publication should not be taken as implying any technical approval by the vehicle manufacturers or importers.

Acknowledgements

Thanks are due to Champion Spark Plugs, who supplied the illustrations showing spark plug conditions. Special thanks to Loders of Yeovil who provided several of the project vehicles used in the origination of this manual. Thanks are also due to Sykes-Pickavant Limited, who provided some of the workshop tools, and to all those people at Sparkford and Newbury Park who helped in the production of this manual.

We take great pride in the accuracy of information given in this manual, but vehicle manufacturers make alterations and design changes during the production run of a particular vehicle of which they do not inform us. No liability can be accepted by the authors or publishers for loss, damage or injury caused by any errors in, or omissions from, the information given.

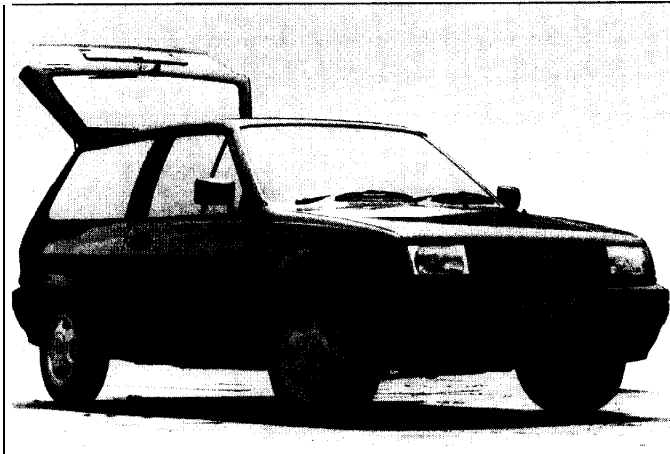

VW Polo Boulevard



VW Polo GT Coupe

Working on your car can be dangerous. This page shows just some of the potential risks and hazards, with the aim of creating a safety-conscious attitude.

General hazards

Scalding

- Don't remove the radiator or expansion tank cap while the engine is hot.
- Engine oil, automatic transmission fluid or power steering fluid may also be dangerously hot if the engine has recently been running.

Burning

- Beware of burns from the exhaust system and from any part of the engine. Brake discs and drums can also be extremely hot immediately after use.

Crushing

- When working under or near a raised vehicle, always supplement the jack with axle stands, or use drive-on ramps.
- **Never** venture under a car which

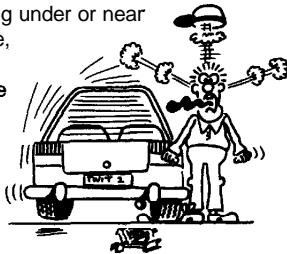

is only supported by a jack.

- Take care if loosening or tightening high-torque nuts when the vehicle is on stands. Initial loosening and final tightening should be done with the wheels on the ground.

Fire

- Fuel is highly flammable; fuel vapour is explosive.
- Don't let fuel spill onto a hot engine.
- Do not smoke or allow naked lights (including pilot lights) anywhere near a vehicle being worked on. Also beware of creating sparks (electrically or by use of tools).
- Fuel vapour is heavier than air, so don't work on the fuel system with the vehicle over an inspection pit.
- Another cause of fire is an electrical overload or short-circuit. Take care when repairing or modifying the vehicle wiring.
- Keep a fire extinguisher handy, of a type suitable for use on fuel and electrical fires.

Electric shock

- Ignition HT voltage can be dangerous, especially to people with heart problems or a pacemaker. Don't work on or near the ignition system with the engine running or the ignition switched on.



- Mains voltage is also dangerous. Make sure that any mains-operated equipment is correctly earthed. Mains power points should be protected by a residual current device (RCD) circuit breaker.

Fume or gas intoxication

- Exhaust fumes are poisonous; they often contain carbon monoxide, which is rapidly fatal if inhaled. Never run the engine in a confined space such as a garage with the doors shut.
- Fuel vapour is also poisonous, as are the vapours from some cleaning solvents and paint thinners.



Poisonous or irritant substances

- Avoid skin contact with battery acid and with any fuel, fluid or lubricant, especially antifreeze, brake hydraulic fluid and Diesel fuel. Don't syphon them by mouth. If such a substance is swallowed or gets into the eyes, seek medical advice.
- Prolonged contact with used engine oil can cause skin cancer. Wear gloves or use a barrier cream if necessary. Change out of oil-soaked clothes and do not keep oily rags in your pocket.
- Air conditioning refrigerant forms a poisonous gas if exposed to a naked flame (including a cigarette). It can also cause skin burning on contact.

Asbestos

- Asbestos dust can cause cancer if inhaled or swallowed. Asbestos may be found in gaskets and in brake and clutch linings. When dealing with such components it is safest to assume that they contain asbestos.

Special hazards

Hydrofluoric acid

- This extremely corrosive acid is formed when certain types of synthetic rubber, found in some O-rings, oil seals, fuel hoses etc, are exposed to temperatures above 400°C. The rubber changes into a charred or sticky substance containing the acid. Once formed, the acid remains dangerous for years. If it gets onto the skin, it may be necessary to amputate the limb concerned.
- When dealing with a vehicle which has suffered a fire, or with components salvaged from such a vehicle, wear protective gloves and discard them after use.

The battery

- Batteries contain sulphuric acid, which attacks clothing, eyes and skin. Take care when topping-up or carrying the battery.
- The hydrogen gas given off by the battery is highly explosive. Never cause a spark or allow a naked light nearby. Be careful when connecting and disconnecting battery chargers or jump leads.

Air bags

- Air bags can cause injury if they go off accidentally. Take care when removing the steering wheel and/or facia. Special storage instructions may apply.

Diesel injection equipment

- Diesel injection pumps supply fuel at very high pressure. Take care when working on the fuel injectors and fuel pipes.

A **Warning: Never expose the hands, face or any other part of the body to injector spray; the fuel can penetrate the skin with potentially fatal results.**

Remember...

DO

- Do use eye protection when using power tools, and when working under the vehicle.
- Do wear gloves or use barrier cream to protect your hands when necessary.
- Do get someone to check periodically that all is well when working alone on the vehicle.
- Do keep loose clothing and long hair well out of the way of moving mechanical parts.
- Do remove rings, wristwatch etc, before working on the vehicle – especially the electrical system.
- Do ensure that any lifting or jacking equipment has a safe working load rating adequate for the job.

DON'T

- Don't attempt to lift a heavy component which may be beyond your capability – get assistance.
- Don't rush to finish a job, or take unverified short cuts.
- Don't use ill-fitting tools which may slip and cause injury.
- Don't leave tools or parts lying around where someone can trip over them. Mop up oil and fuel spills at once.
- Don't allow children or pets to play in or near a vehicle being worked on.

0.6 Roadside repairs

The following pages are intended to help in dealing with common roadside emergencies and breakdowns. You will find more detailed fault finding information at the back of the manual, and repair information in the main chapters.

If your car won't start and the starter motor doesn't turn

- 0 Open the bonnet and make sure that the battery terminals are clean and tight.
- 0 Switch on the headlights and try to start the engine. If the headlights go very dim when you're trying to start, the battery is probably flat. Get out of trouble by jump starting (see next page) using a friend's car.

If your car won't start even though the starter motor turns as normal

- 0 Is there fuel in the tank?
- 0 Is there moisture on electrical components under the bonnet? Switch off the ignition, then wipe off any obvious dampness with a dry cloth. Spray a water-repellent aerosol product (WD-40 or equivalent) on ignition and fuel system electrical connectors like those shown in the photos. Pay special attention to the ignition coil wiring connector and H-T leads.



A Check that the spark plug HT leads are securely connected by pushing them down onto the plug tops

B Check that the distributor hall sender connector is firmly pushed home and free of moisture

C At the ignition coil, check that the LT and HT cable connections are secure and free of moisture

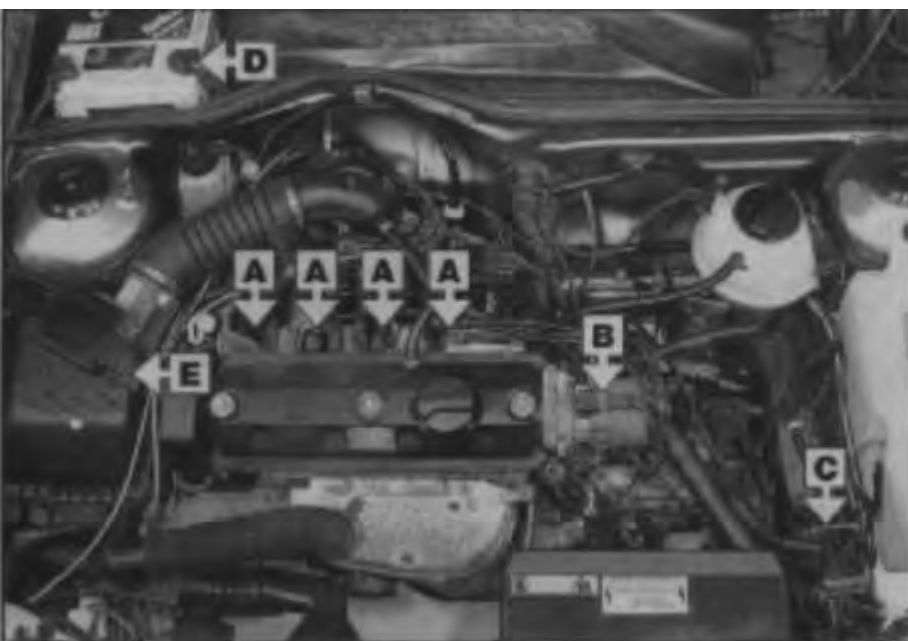

D Ensure that the battery cable connections are secure



With the ignition switched off, check that electrical connections are secure and spray them with a water dispersant spray, such as **WD40**, if you suspect that moisture may be causing a problem.

E Check that the airflow meter harness connector is secure and free of moisture

HAYNES
HINT

Jump starting will get you out of trouble, but you must correct whatever made the battery go flat in the first place. There are three possibilities:

- 1** *The battery has been drained by repeated attempts to start, or by leaving the lights on.*
- 2** *The charging system is not working properly (alternator drivebelt slack or broken, alternator wiring fault or alternator itself faulty).*
- 3** *The battery itself is at fault (electrolyte low, or battery worn out).*

When jump-starting a car using a booster battery, observe the following precautions:

- 1 Before connecting the booster battery, make sure that the ignition is switched off.
- 2 Ensure that all electrical equipment (lights, heater, wipers, etc) is switched off.
- 3 Make sure that the booster battery is the same voltage as the discharged one in the vehicle.
- 4 If the battery is being jump-started from the battery in another vehicle, the two vehicles **MUST NOT TOUCH** each other.
- 5/ Make sure that the transmission is in neutral (or PARK, in the case of automatic transmission).

Jump starting



1 Connect one end of the red jump lead to the positive (+) terminal of the flat battery

2 Connect the other end of the red lead to the positive (+) terminal of the booster battery.

3 Connect one end of the black jump lead to the negative (-) terminal of the booster battery

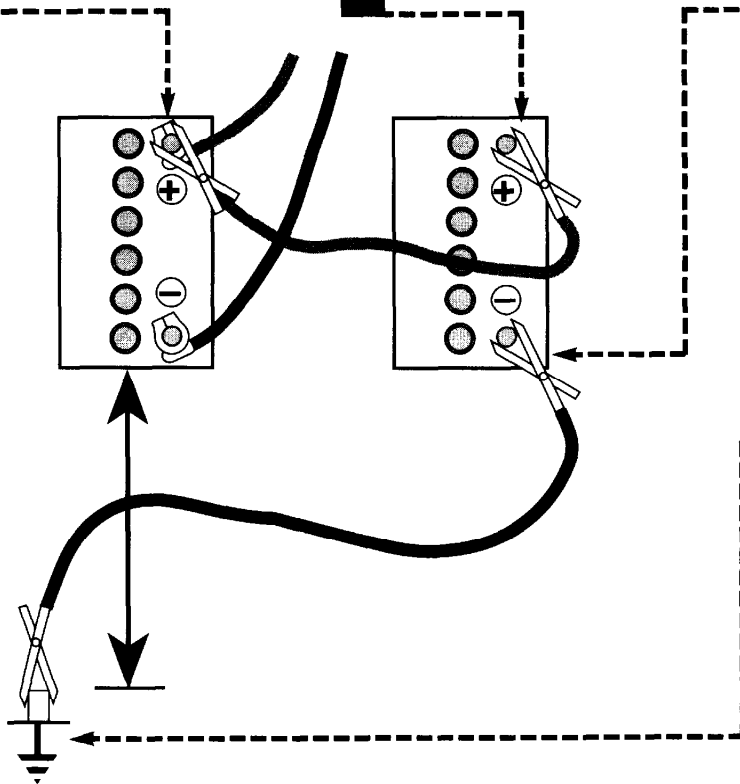

4 Connect the other end of the black jump lead to a bolt or bracket on the engine block, well away from the battery, on the vehicle to be started.

5 Make sure that the jump leads will not come into contact with the fan, drivebelts or other moving parts of the engine.

6 Start the engine using the booster battery, then with the engine running at idle speed, disconnect the jump leads in the reverse order of connection.

0.8 Roadside repairs

Wheel changing

Some of the details shown here will vary according to model. For instance, the location of the spare wheel and jack is not the same on all cars. However, the basic principles apply to all vehicles.

Preparation

- 0 When a puncture occurs, stop as soon as it is safe to do so.
- 0 Park on firm level ground, if possible, and well out of the way of other traffic.
- Use hazard warning lights if necessary.
- 0 If you have one, use a warning triangle to alert other drivers of your presence.
- 0 Apply the handbrake and engage first or reverse gear (or Park on models with automatic transmission).
- 0 Chock the wheel diagonally opposite the one being removed - a couple of large stones will do for this.
- 0 If the ground is soft, use a flat piece of wood to spread the load under the jack.

Changing the wheel

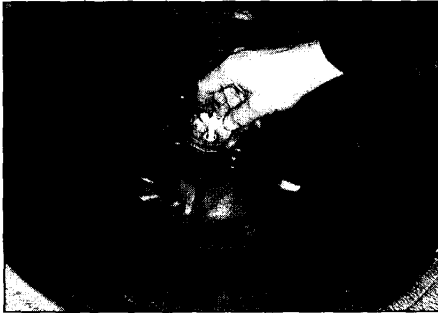

- 1 The spare wheel and tools are stored in the luggage compartment. Unscrew the wing nut and lift out the spare wheel

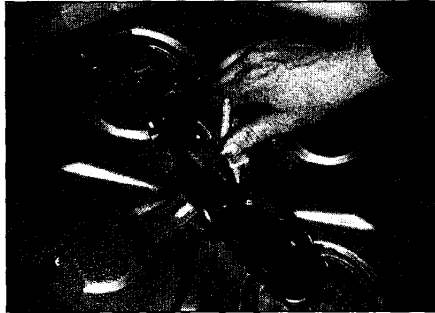

- 2 The jack is located beneath the spare wheel. The wheel brace is on the right-hand side of the luggage compartment

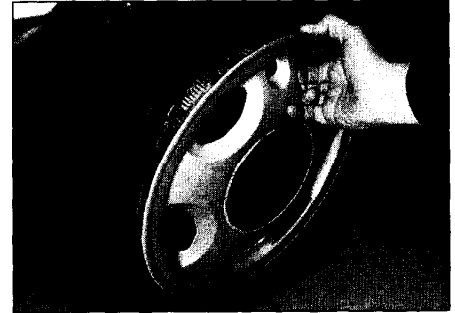

- 3 Remove the wheel trim . . .

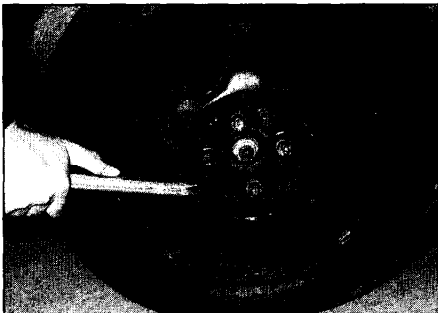

- 4 . . . then slacken each wheel bolt by a half turn

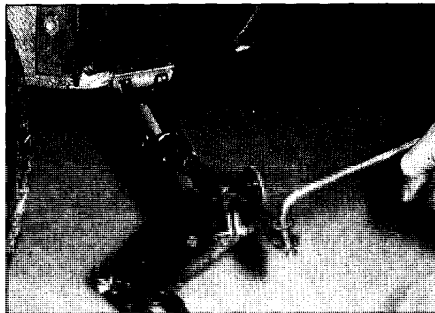

- 5 Locate the jack below the reinforced point on the sill (don't jack the vehicle at any other point of the sill) and on firm ground then turn the jack handle clockwise until the wheel is raised clear of the ground

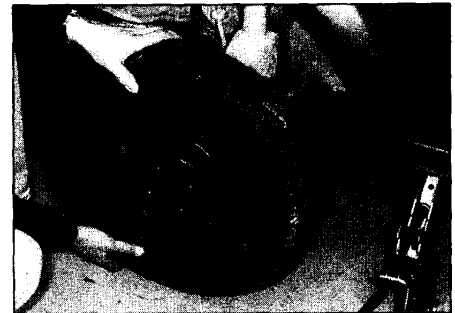

- 6 Unscrew the wheel bolts and remove the wheel. Fit the spare wheel, and screw in the bolts. Lightly tighten the bolts with the brace, and lower the vehicle to the ground.

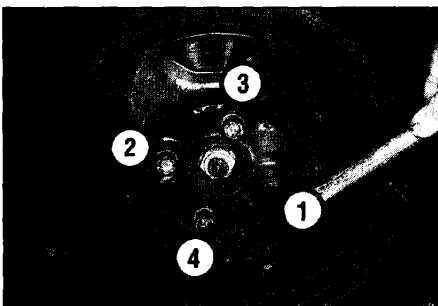

- 7 Securely tighten the wheel bolts in the sequence shown, Refit the wheel trim, and stow the punctured wheel and tools.

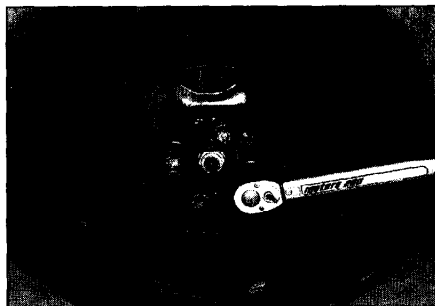

- 8 The wheel bolts should be slackened and retightened to the specified torque at the earliest possible opportunity

Finally...

- 0 Remove the wheel chocks.
- 0 Stow the jack and tools in the correct locations in the car.
- 0 Check the tyre pressure on the wheel just fitted. If it is low, or if you don't have a pressure gauge with you, drive slowly to the nearest garage and inflate the tyre to the right pressure.
- 0 Have the damaged tyre or wheel repaired as soon as possible.

Identifying leaks

Puddles on the garage floor or drive, or obvious wetness under the bonnet or underneath the car, suggest a leak that needs investigating. It can sometimes be difficult to decide where the leak is coming from, especially if the engine bay is very dirty already. Leaking oil or fluid can also be blown rearwards by the passage of air under the car, giving a false impression of where the problem lies.

A **Warning:** *Most automotive oils and fluids are poisonous. Wash them off skin, and change out of contaminated clothing, without delay.*

HAYNES
HINT

The smell of a fluid leaking from the car may provide a clue to what's leaking. Some fluids are distinctively coloured. It may help to clean the car and to park it over some clean paper as an aid to locating the source of the leak. Remember that some leaks may only occur while the engine is running.

Sump oil



Engine oil may leak from the drain plug...

Oil from filter



...or from the base of the oil filter.

Gearbox oil

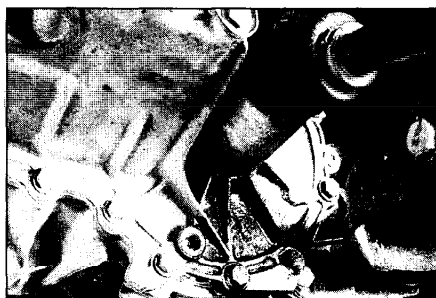

Gearbox oil can leak from the seals at the inboard ends of the driveshafts.

Antifreeze



Leaking antifreeze often leaves a crystalline deposit like this.

Brake fluid

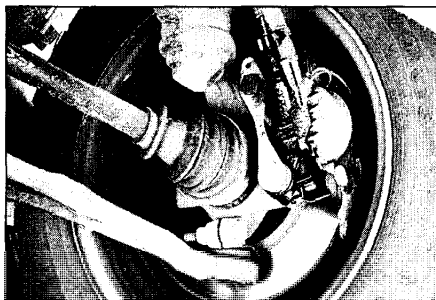

A leak occurring at a wheel is almost certainly brake fluid.

Power steering fluid

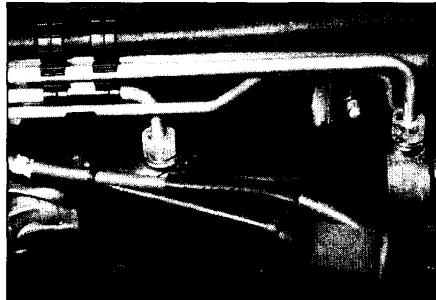

Power steering fluid may leak from the pipe connectors on the steering rack.

When all else fails, you may find yourself having to get a tow home - or of course you may be helping somebody else. Long-distance recovery should only be done by a garage or breakdown service. For shorter distances, DIY towing using another car is easy enough, but observe the following points:

- Use a proper tow-rope - they are not expensive. The vehicle being towed must display an 'ON TOW' sign in its rear window.
- Always turn the ignition key to the 'on' position when the vehicle is being towed, so that the steering lock is released, and that the direction indicator and brake lights will work.
- 0 Only attach the tow-rope to the towing eyes provided.
- 0 Before being towed, release the handbrake and select neutral on the transmission.
- 0 Note that greater-than-usual pedal

pressure will be required to operate the brakes, since the vacuum servo unit is only operational with the engine running.

- 0 On models with power steering, greater-than-usual steering effort will also be required.
- 0 The driver of the car being towed must keep the tow-rope taut at all times to avoid snatching.
- 0 Make sure that both drivers know the route before setting off.
- Only drive at moderate speeds and keep the distance towed to a minimum. Drive smoothly and allow plenty of time for slowing down at junctions.
- The front towing eye is supplied as part 01 the tool kit stored in the luggage compartment. To fit the eye, carefully prise out the removable panel from the front bumper. Securely screw the eye into position,

(noting that on some models it may have a **left-handed thread**) and tighten using the wheelbrace handle (**see illustration**).

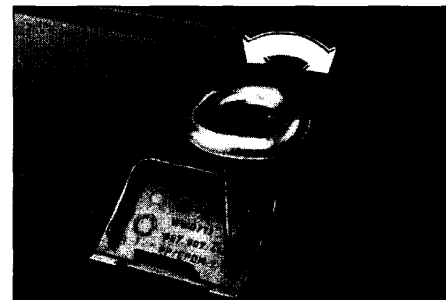

The front towing eye is supplied as part of the vehicle tool kit and must be screwed into position

Towing

0.10 Weekly checks



Introduction

There are some very simple checks which need only take a few minutes to carry out, but which could save you a lot of inconvenience and expense.

These "Weekly checks" require no great skill or special tools, and the small amount of time they take to perform could prove to be very well spent, for example;

□ Keeping an eye on tyre condition and pressures, will not only help to stop them wearing out prematurely, but could also save your life.

0 Many breakdowns are caused by electrical problems. Battery-related faults are particularly common, and a quick check on a regular basis will often prevent the majority of these.

□ If your car develops a brake fluid leak, the first time you might know about it is when your brakes don't work properly. Checking the level regularly will give advance warning of this kind of problem.

0 If the oil or coolant levels run low, the cost of repairing any engine damage will be far greater than fixing the leak, for example.

Underbonnet check points

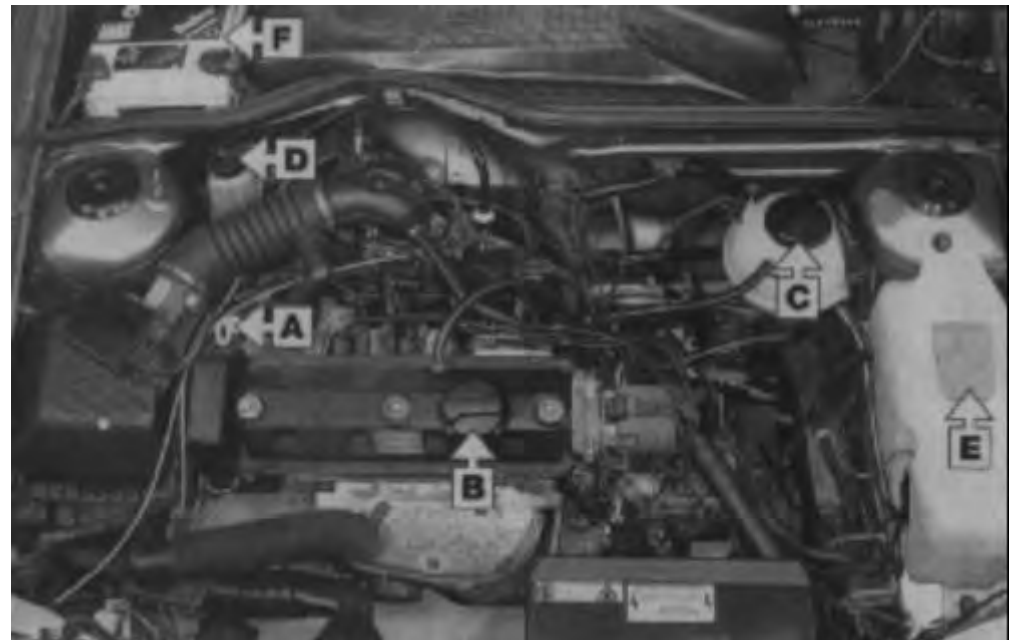

1 1.3 litre model

- A Engine oil level dipstick
- B Engine oil filler cap
- C Coolant expansion tank
- D Brake fluid reservoir
- E Screen washer fluid reservoir
- F Battery

Engine oil level

Before you start

V Make sure that your car is on level ground.
V Check the oil level before the car is driven, or at least 5 minutes after the engine has been switched off.

HAYNES *If the oil is checked immediately after driving the vehicle, some of the oil will remain in the upper engine components, resulting in an inaccurate reading on the dipstick!*

HINT

The correct oil

Modern engines place great demands on their oil. It is very important that the correct oil for your car is used (See "Lubricants, fluids and tyre pressures").

Car Care

0 If you have to add oil frequently, you should check whether you have any oil leaks. Place some clean paper under the car overnight, and check for stains in the morning. If there are no leaks, the engine may be burning oil (see "Fault Finding"). Overfilling the engine with oil may lead to catalytic converter failure.

- Always maintain the level between the upper and lower dipstick marks (see photo 3). If the level is too low severe engine damage may occur. Oil seal failure may result if the engine is overfilled by adding too much oil.



1 The dipstick top is often brightly coloured for easy identification (see "Underbonnet check points" on page 0.10 for exact location). Withdraw the dipstick from its tube.



2 Using a clean rag, remove all oil from the dipstick. Insert the clean dipstick into the tube as far as it will go, then withdraw it again. Keep the handle up so the oil doesn't run along the dipstick to give a false reading.

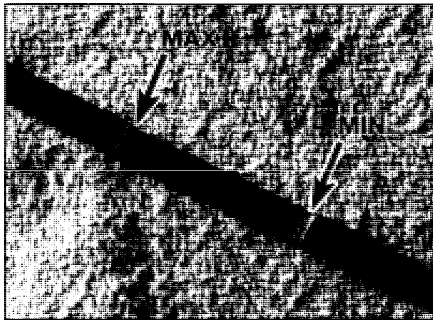

3 Note the oil level on the end of the dipstick, which should be between the upper ('MAX') mark and the lower ('MIN') mark. Adding approximately 1.0 litre of oil will raise the level from the lower to the upper mark.



4 Oil is added through the oil filler cap - unscrew the cap and top up the level; a funnel may help to reduce spillage. Add the oil 0.5 litre at a time, checking the level on the dipstick frequently. DO NOT overfill the engine (see Car Care).

Coolant level

A **Warning: DO NOT attempt to remove the expansion tank pressure cap when the engine is hot, as there is a very great risk of scalding. Do not leave open containers of coolant about, as it is poisonous.**

Car Care

0 With a sealed-type cooling system, adding coolant should not be necessary on a regular basis. If frequent topping-up is required, it is likely there is a leak. Check the radiator, all hoses and joint faces for signs of staining or wetness, and rectify as necessary.

0 It is important that antifreeze is used in the cooling system all year round, not just during the winter months. Don't top-up with water alone, as the antifreeze will become too diluted.

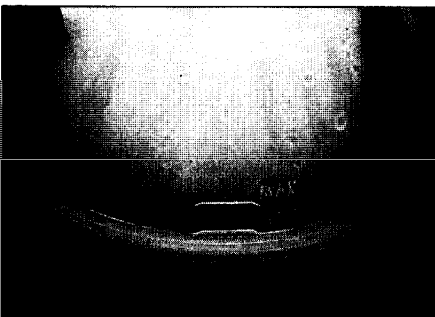

1 The coolant level varies with the temperature of the engine. When the engine is cold, the coolant level should be between the "MAX" and "MIN" marks. When hot, the level may rise above the "MAX" mark.

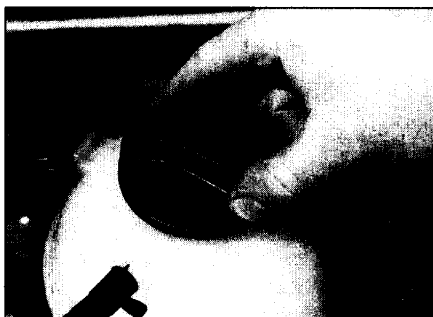

2 If topping up is necessary, wait until the engine is cold. Slowly unscrew the expansion tank cap, to release any pressure present in the cooling system, and remove it.



3 Add a mixture of water and antifreeze to the expansion tank until the coolant level is halfway between the level marks. Refit the cap and tighten it securely.

0.12 Weekly checks

Brake fluid level



Warning:

0 Brake fluid can harm your eyes and damage painted surfaces, so use extreme caution when handling and pouring it.

0 Do not use fluid that has been standing open for some time, as it absorbs moisture from the air, which can cause a dangerous loss of braking effectiveness.

**HAYNES
HiNT**

- Make sure that your car is on level ground.
- The fluid level in the reservoir will drop slightly as the brake pads wear down, but the fluid level must never be allowed to drop below the "MIN" mark.

Safety First!

0 If the reservoir requires repeated topping-up this is an indication of a fluid leak somewhere in the system, which should be investigated immediately.

0 If a leak is suspected, the car should not be driven until the braking system has been checked. Never take any risks where brakes are concerned.

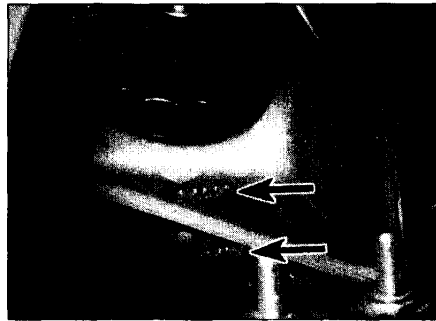

1 The "MAX" and "MIN" marks are shown on the front of the reservoir. The fluid level must be kept between the marks at all times. If topping-up is necessary, first clean around the reservoir cap.

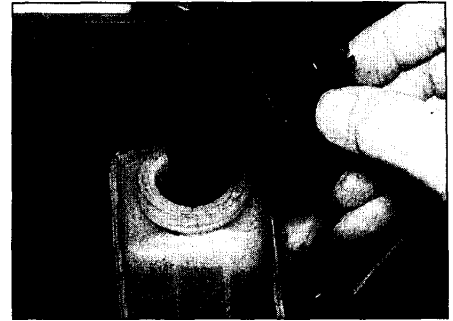

2 Unscrew the cap and carefully lift it out, taking care not to damage the level switch float. Inspect the reservoir; if the fluid is dirty the hydraulic system should be drained and refilled (see Chapter 1)



3 Carefully add fluid, taking care not to spill it onto the surrounding components. Use only the specified fluid; mixing different types can cause damage to the system. After topping-up to the correct level, securely refit the cap and wipe off any spilt fluid

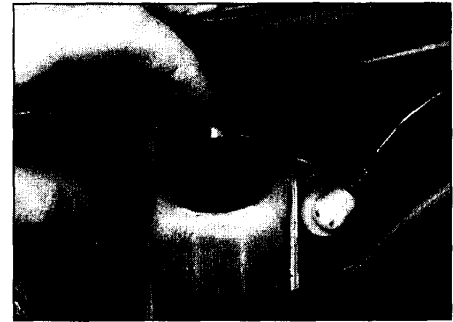

4 After topping-up the fluid level have an assistant depress the warning light test plunger on the top of the reservoir. With the ignition switched on, the warning light on the instrument panel should light up

Screen washer fluid level

Screenwash additives not only keep the windscreen clean during foul weather, they also prevent the washer system freezing in cold weather - which is when you are likely to need it most. Don't top up using plain water as the screenwash will become too diluted, and will freeze during cold weather.

On no account use coolant antifreeze in the washer system - this could discolour or damage paintwork.



1 The screen washer fluid reservoir (arrowed) is located in the front left-hand corner of the engine compartment.



2 The screen washer level can be seen through the reservoir body. If topping-up is necessary, open the cap. When topping-up the reservoir, add a screenwash additive in the quantities recommended on the bottle.

Wiper blades

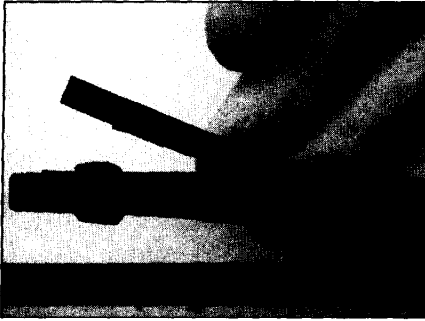

1 Check the condition of the wiper blades; if they are cracked or show any signs of deterioration, or if the glass swept area is smeared, renew them. Wiper blades should be renewed annually.

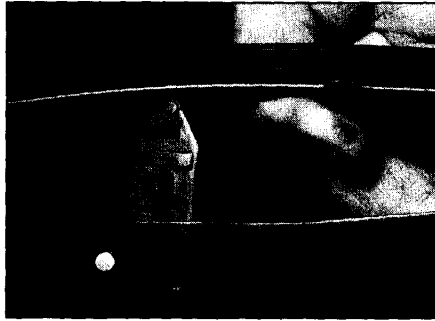

2 To remove a windscreen wiper blade, pull the arm fully away from the screen until it locks. Swivel the blade through 90° and slide it downwards . . .



3 . . . then remove the blade from the arm.

Battery

Caution: Before carrying out any work on the vehicle battery, read the precautions given in "Safety first" at the start of this manual,

(/ Make sure that the battery tray is in good condition, and that the clamp is tight. Corrosion on the tray, retaining clamp and the battery itself can be removed with a solution of water and baking soda. Thoroughly rinse all cleaned areas with water. Any metal parts damaged by corrosion should be covered with a zinc-based primer, then painted.

(/Periodically (approximately every three months), check the charge condition of the battery as described in Chapter 5A.

d If the battery is flat, and you need to jump start your vehicle, see **Roadside Repairs**.



1 The battery is located in the plenum chamber at the rear right-hand side of the engine compartment. The exterior of the battery should be inspected periodically for damage such as a cracked case or cover.

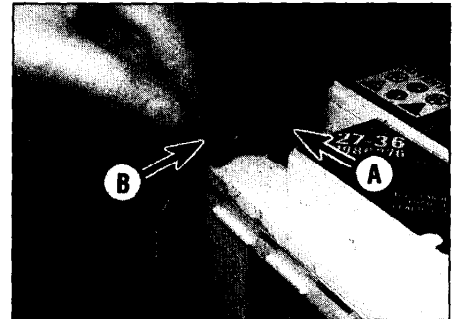

2 Check the tightness of battery clamps (A) to ensure good electrical connections. You should not be able to move them. Also check each cable (B) for cracks and frayed conductors.



Battery corrosion can be kept to a minimum by applying a layer of petroleum jelly to the clamps and terminals after they are reconnected.

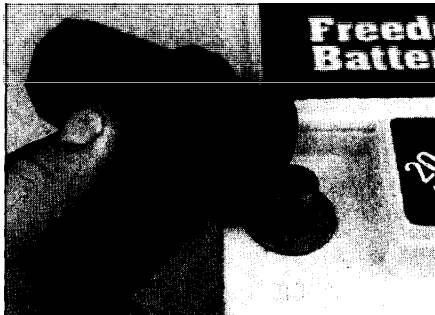

3 If corrosion (white, fluffy deposits) is evident, remove the cables from the battery terminals, clean them with a small wire brush, then refit them. Automotive stores sell a tool for cleaning the battery post . . .



4 . . . as well as the battery cable clamps

0.14 Weekly checks

Tyre condition and pressure

It is very important that tyres are in good condition, and at the correct pressure - having a tyre failure at any speed is highly dangerous. Tyre wear is influenced by driving style - harsh braking and acceleration, or fast cornering, will all produce more rapid tyre wear. As a general rule, the front tyres wear out faster than the rears. Interchanging the tyres from front to rear ("rotating" the tyres) may result in more even wear. However, if this is completely effective, you may have the expense of replacing all four tyres at once!

Remove any nails or stones embedded in the tread before they penetrate the tyre to cause deflation. If removal of a nail does reveal that

the tyre has been punctured, refit the nail so that its point of penetration is marked. Then immediately change the wheel, and have the tyre repaired by a tyre dealer.

Regularly check the tyres for damage in the form of cuts or bulges, especially in the sidewalls. Periodically remove the wheels, and clean any dirt or mud from the inside and outside surfaces. Examine the wheel rims for signs of rusting, corrosion or other damage. Light alloy wheels are easily damaged by "kerbing" whilst parking; steel wheels may also become dented or buckled. A new wheel is very often the only way to overcome severe damage.

New tyres should be balanced when they are fitted, but it may become necessary to re-balance them as they wear, or if the balance weights fitted to the wheel rim should fall off. Unbalanced tyres will wear more quickly, as will the steering and suspension components. Wheel imbalance is normally signified by vibration, particularly at a certain speed (typically around 50 mph). If this vibration is felt only through the steering, then it is likely that just the front wheels need balancing. If, however, the vibration is felt through the whole car, the rear wheels could be out of balance. Wheel balancing should be carried out by a tyre dealer or garage.



1 Tread Depth - visual check

The original tyres have tread wear safety bands (B), which will appear when the tread depth reaches approximately 1.6 mm. The band positions are indicated by a triangular mark on the tyre sidewall (A).



2 Tread Depth - manual check

Alternatively, tread wear can be monitored with a simple, inexpensive device known as a tread depth indicator gauge.



3 Tyre Pressure Check

Check the tyre pressures regularly with the tyres cold. Do not adjust the tyre pressures immediately after the vehicle has been used, or an inaccurate setting will result.

Tyre tread wear patterns



Shoulder Wear

Underinflation (wear on both sides)

Under-inflation will cause overheating of the tyre, because the tyre will flex too much, and the tread will not sit correctly on the road surface. This will cause a loss of grip and excessive wear, not to mention the danger of sudden tyre failure due to heat build-up.

Check and adjust pressures

Incorrect wheel camber (wear on one side)

Repair or renew suspension parts

Hard cornering

Reduce speed!



Centre Wear

Overinflation

Over-inflation will cause rapid wear of the centre part of the tyre tread, coupled with reduced grip, harsher ride, and the danger of shock damage occurring in the tyre casing.

Check and adjust pressures

If you sometimes have to inflate your car's tyres to the higher pressures specified for maximum load or sustained high speed, don't forget to reduce the pressures to normal afterwards.



Uneven Wear

Front tyres may wear unevenly as a result of wheel misalignment. Most tyre dealers and garages can check and adjust the wheel alignment (or "tracking") for a modest charge.

Incorrect camber or castor

Repair or renew suspension parts

Malfunctioning suspension

Repair or renew suspension parts

Unbalanced wheel

Balance tyres

Incorrect toe setting

Adjust front wheel alignment

Note: *The feathered edge of the tread which typifies toe wear is best checked by fee/.*

Bulbs and fuses

0 Check all external lights and the horn. Refer to the appropriate Sections of Chapter 12 for details if any of the circuits are found to be inoperative.

(Visually check all accessible wiring connectors, harnesses and retaining clips for security, and for signs of chafing or damage.

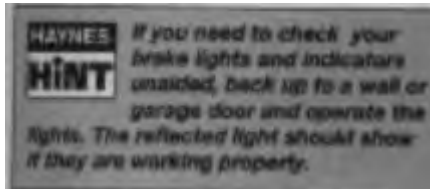

1 If a single indicator light, stop-light or headlight has failed, it is likely that a bulb has blown and will need to be replaced. Refer to Chapter 12 for details. If both stop-lights have failed, it is possible that the switch has failed (see Chapter 9).

2 If more than one indicator light or tail light has failed it is likely that either a fuse has blown or that there is a fault in the circuit. The fuses are located in the plenum chamber at the left-hand rear of the engine compartment. To replace a blown fuse, squeeze the cover and remove it from the fusebox, then simply pull out the blown fuse and fit a new one of the correct rating. If the fuse blows again, it is important that you find out why - a complete checking procedure is given in Chapter 12.

0.16 Lubricants, fluids and tyre pressures

Lubricants and fluids

Engine	Multigrade engine oil, viscosity SAE 10W/40 to 20W/50, to WV specification 501 01
Cooling system	Ethylene glycol based antifreeze
Manual transmission	Gear oil, viscosity SAE 80 or 75W-90
Braking system	Hydraulic fluid to SAE J1703F or DOT4

Tyre pressures

Up to half load - bar (psi):	Front	Rear
135R13	1.9 (28)	1.9(28)
145R13	1.7 (25)	1.7 (25)
155/70R13	1.8 (26)	1.8 (26)
165/65R13 or 175/60R13	1.8 (26)	1.8 (26)

Full load - bar (psi):	Front	Rear
135R13	2.2 (32)	2.5 (36)
145R13	1.9 (28)	2.2 (32)
155/70R13	2.1 (31)	2.4 (35)
165/65R13 or 175/60R13	2.2 (32)	2.6 (38)

Note: Pressures apply only to original-equipment tyres, and **may vary** slightly if any other make of tyre is fitted; check with the tyre manufacturer or supplier for the correct pressures if necessary. The correct pressures for each individual vehicle are usually given on a sticker inside the glovebox lid or inside the fuel filler flap. This information may conflict with that shown above - in this case, consult your VW dealer for the latest recommendations.

The spare wheel should be kept at the highest full-load pressure.

Chapter 1





Routine maintenance and servicing



Contents

Air filter renewal	17	Fuel filter renewal	21
Auxiliary drivebelt check and renewal	15	Headlight beam alignment check	11
Brake fluid renewal	22	Hinge and lock lubrication	6
Brake system and fluid leakage check	7	Hose and fluid leak check	5
Clutch play	4	Rear brake shoe check - models with rear drum brakes	3
Coolant renewal	23	Roadtest	12
Driveshaft gaiter check	10	Sliding roof runner lubrication	18
Engine management system check	13	Spark plug renewal	16
Engine oil and filter renewal	1	Steering and suspension check	
Exhaust emission and idle speed check	14	Timing belt renewal	20
Exhaust system check	8	Underbody sealant condition check	19
Front brake pad check	2		

Degrees of difficulty

Easy , suitable for novice with little experience 	Fairly easy , suitable for beginner with some experience 	Fairly difficult , suitable for competent DIY mechanic 	Difficult , suitable for experienced DIY mechanic 	Very difficult , suitable for expert DIY or professional 
---	--	--	---	--

1.2 Servicing specifications

Lubricants and fluids - Refer to end of "weekly checks"

Capacities

Engine oil

All except G40 models	3.5 litres
G40models	3.25 litres

Cooling system	5.6 litres (approx)
-----------------------------	---------------------

Transmission

4speed models	2.2 litres
5speed models	3.1 litres

Fueltank	42 litres
-----------------------	-----------

Washer reservoirs

Models with headlight washers	4.5 litres
Models without headlight washers	7.5 litres

Engine

Oil filter:	
Engine codes AAU, 3F (to 07/92), PY (to 07/90)	Champion C160
Engine codes AAV, 3F (from 08192)	Champion C181
Engine codes PY (from 08/90)	Champion C155

Cooling system

Antifreeze mixture:	
28% antifreeze	Protection down to -15°C (5°F)
50% antifreeze	Protection down to -30°C (-22°F)

Note: Refer to antifreeze manufacturer for latest recommendations.

Fuel system

Air filter element:	
Enginecodes AAUAAV	Champion W102
EnginecodesPY,3F	Champion U505
Fuel filter	Champion L206

Ignition system

Ignition timing, all models (basic setting)	5± 1° BTDC
Spark plugs:	
EnginecodesAAU,AAV	Champion N7BYC
Enginecodes3F,PY	Champion NGBYC
Electrodegap	N/A (refer to spark plug manufacturer's specification)

Auxiliary drivebelt (v-belt) deflection

New belt	2 mm max.
Used belt	5 mm max.

Brakes

Brake pad friction material minimum thickness (including backplate) ..	7.0 mm
Brake shoe friction material minimum thickness	2.5 mm

Torque wrench settings

	Nm	lbf ft
Alternator tensioning nut:		
Initial tightening:		
New belt	8	6
Used belt	4	3
Final tightening	8	6
Alternator tensioning nut lockscrew	35	26
Alternator upper mounting screws	35	26
Alternator tensioning strut screws	20	15
G-charger bracket tensioning torque:		
New belt	135	100
Used belt	80	59
G-charger mounting bracket screws:		
M12 screws	80	59
M8 screws	30	22
Sumpdrainplug	30	22
Spark plugs:		
All models except G40	20	15
G40 models	25	18
Wheel bolts	110	81

Maintenance schedule 1.3

The maintenance intervals in this manual are provided with the assumption that you, not the dealer, will be carrying out the work. These are the minimum maintenance intervals recommended by us for vehicles driven daily.

If you wish to keep your vehicle in peak condition at all times, you may wish to perform some of these procedures more often. We encourage frequent maintenance, because it enhances the efficiency,

performance and resale value of your vehicle. When the vehicle is new, it should be serviced by a factory-authorized dealer service department, in order to preserve the factory warranty.

Weekly, or every 250 miles (400 km)

- See "Weekly checks"

Every 10 000 miles (15 000 km) or 12 months, whichever comes first

- Renew engine oil and filter (Section 1)
- Check the front brake pad lining thickness (Section 2)

Every 12 months - regardless of mileage

Note: In addition to the items listed previously, carry out the following:

- Check the rear brake shoes and drums (Section 3)
- Check clutch play (Section 4)
- Check all underbonnet components and hoses for fluid leaks (Section 5)
- Lubricate all hinges and locks (Section 6)
- Check all brake system components for damage or fluid leakage (Section 7)
- Check the condition of the exhaust system and its mountings (Section 8)
- Check the steering and suspension components for condition and security (Section 9)
- Check the condition of the driveshaft gaiters (Section 10)
- Check the headlight beam adjustment (Section 11)
- Carry out a road test (Section 12)
- Engine management system check (Section 13)
- Exhaust emission and idle speed check (Section 14)

Every 20 000 miles (30 000 km)

Note: In addition to the items listed in the previous sub-Section carry out the following:

- Check the condition of the auxiliary drivebelt(s), and renew if necessary (Section 15)
- Renew the spark plugs (Section 16)
- Renew the air filter element and clean out the air cleaner housing (Section 17)
- Lubricate the sliding roof runners (Section 18)
- Check the underbody sealant for damage (Section 19)

Every 60 000 miles

- Renew the camshaft timing belt (Section 20)
- Renew the fuel filter (Section 21)

Every 2 years - regardless of mileage

- Renew the brake fluid (Section 22)
- Renew the coolant (Section 23)